

Sistemi Notte
EN Night Systems

PIANCA

Sistemi Notte

EN Night Systems

PIANCA

PIANCA

Company Profile

Pianca è un importante marchio italiano nel settore di sistemi e complementi d'arredo per la casa, che si caratterizza per la ricerca di essenzialità ed un gusto elegante e sobrio. Ogni creazione, dagli armadi ai programmi per zona notte e per la zona giorno, alle librerie, ai tavoli, ai divani, fino alle sedie e agli accessori, viene ideata per essere personalizzabile in forme, misure e finiture. È una produzione articolata che unisce bellezza e creatività italiana alla libertà di “vestire su misura” la propria casa secondo i propri bisogni o esigenze.

Origini

Da ben 14 generazioni la famiglia è specializzata nell'arte della falegnameria. La storia racconta che intorno al 1500, la famiglia detta “da Pianca” conduceva una rinomata falegnameria dotata di un mulino, alimentato da un corso d'acqua. L'arte ebanista venne tramandata di padre in figlio e molte sono le realizzazioni di pregio tuttora visibili in ville e chiese del trevigiano. A metà degli anni '50, Enrico Pianca trasforma l'attività da manifattura a industria, creando

Pianca is a major, well-known Italian industrial brand that produces furniture systems and accessories distinguished by an elegant, minimal and understated style. Each of our creations - including wardrobes, living and bedroom collections, bookshelves, tables, sofas, chairs and accessories – is designed to be customised in terms of shape, dimensions and finishes. Our extensive range of furniture is a perfect blend of Italian creativity and beauty, paired with the freedom to tailor your home to suit your needs and requirements.

Origins

The Pianca family is specialised in the art of cabinet-making and can count on a tradition 14 generations long. In fact, history tells us that around 1500 a family called “da Pianca” used to manage a well-known carpenter's shop with a mill driven by a small stream. The art of cabinet-making was passed down from father to son and many prized artefacts in churches and villas of the Treviso province bear witness to this. In the mid-50s, Enrico Pianca transformed his business

le basi per uno sviluppo futuro. Pur investendo sulle più razionali concezioni produttive, egli non rinuncia alle competenze e professionalità acquisite nel tempo e mantiene all'interno della moderna azienda un reparto di lavorazioni strettamente manuali, dove il prof. Giovanni Battista Pianca, cugino-fratello di Enrico, guida una squadra di giovani ebanisti. Decide di progettare il sapere dei suoi operai ed artigiani nell'avveniristico mondo del design, che ancora non si chiama nemmeno così, ed è presente ininterrottamente fin dalla prima Edizione del Salone del Mobile di Milano dal 1961. Negli anni '80 il figlio Aldo subentra nella conduzione dell'azienda. Con lui la produzione si evolve in un sistema d'arredo completo mentre la distribuzione si espande ai mercati internazionali all'insegna di uno stile italiano moderno, funzionale ed elegante. Negli anni '90 Pianca implementa un modello di produzione sostenibile e flessibile con servizio "just in time" per sistemi d'arredo che garantiscono molteplici possibilità compositive personalizzabili su misura.

Made In Italy

Il nostro essere italiani è garanzia di qualità universalmente riconosciuta e lo viviamo come un marchio da tutelare. A garanzia della massima qualità, Pianca sceglie fornitori italiani e realizza internamente tutte le fasi della produzione. Dalla Marca esportiamo nel mondo l'eleganza e il pregio delle lavorazioni Made in Italy.

Design

La ricerca del design Pianca si rinnova con costanza e coerenza, al fine di rispondere alle esigenze del vivere moderno e soddisfare il gusto contemporaneo in continua

from a cabinet maker's workshop to a full-blown factory, creating the basis for future development. Although he invested in the most rational productive systems, he didn't want to give up the expertise and skills gained over time and decided to dedicate a section of the factory to handcrafted creations, where Giovanni Battista Pianca, Enrico's cousin, lead a team of young cabinet makers. Enrico then decided to project the knowledge of his trusted workers and artisans into the futuristic world of design (it wasn't even known by that name yet!) and started to present his products at every Salone del Mobile in Milan from the very first edition in 1961. In the 80s, Aldo - Enrico Pianca's son - took the helm of the company. With him, production grew and developed into a complete furnishing system while distribution expanded to international markets, all in the name of a modern, functional and elegant Italian style. In the 90s, Pianca introduced a flexible and sustainable "just in time" production model to deliver highly customisable furnishing systems tailored to suit any taste or requirement.

Made In Italy

The fact that we are Italian is a universally recognised guarantee of quality, and we see it as a hallmark to be safeguarded. To guarantee the best possible quality, Pianca chooses Italian suppliers and performs each step of the production process inside its production plant. From our region we export the elegance and luxury of Italian-made products across the globe.

Design

Pianca's design is constantly and consistently renewing itself to satisfy the needs of modern



1956 Enrico Pianca trasforma la storica attività manifatturiera in industria, ^{EN} 1956 Enrico Pianca transforms a carpenter shop into a factory



1970 Europremio dell'arredamento per l'alta qualità dei prodotti - Palazzo dei Congressi Roma, ^{EN} 1970 Europremio prize for high-quality furniture - Palazzo dei Congressi, Rome

evoluzione, mantenendo essenzialità, sobrietà ed eleganza, valori che caratterizzano ogni prodotto e rendono riconoscibile lo stile Pianca.

Savoir Faire

La nostra azienda è fatta prima di tutto di persone. Il loro immenso valore è il nostro primo capitale, un bagaglio di conoscenze e abilità che solo l'esperienza fa conquistare nel tempo. C'è il gusto di Marta dietro la scelta dei legni, la perizia di Luca a garantire la perfezione delle laccature, l'occhio attento di Giacomo al controllo qualità. Per noi è così da sempre. Produciamo design, ma usiamo ancora le mani, e ci sentiamo sempre artigiani.

Sostenibilità

Pianca fa uso di legno ecosostenibile, proveniente da boschi certificati a prelievo controllato contro la deforestazione e di pannelli esenti da colle tossiche. Siamo stati i primi a impiegare le laccature lucide ad acqua per la salute dei nostri dipendenti e per abbattere l'inquinamento domestico. Gli scarti di lavorazione vengono riutilizzati in caldaie per produrre energia termica, l'impiego di pannelli fotovoltaici producono un Megawatt di energia elettrica, mentre i sistemi di imballaggio sono al 100% automatizzati e riciclabili, tanto che anche Amazon, l'azienda americana di commercio elettronico, nel 2014 ha voluto visitare Pianca per capire i segreti del suo imballaggio d'avanguardia.

Customer Care

Ci affidiamo a un selezionato network di rivenditori formati, in grado di fornire massime garanzie di qualità, assistendo il

lifestyles and ever-changing contemporary tastes while preserving the minimalism, understatement and elegance that have become its hallmark and are typical values of all its products.

Savoir Faire

First and foremost, our company is made of people. Their immense value is our greatest asset, with their wealth of knowledge and skills that only time and experience can bring. Marta's taste lies behind the choice of wood species, Luca's expertise guarantees the perfection of lacquers, Giacomo's careful eye ensures rigorous quality control. That's the way it's always been here at Pianca. We produce design, but we still use our hands, and we still consider ourselves craftsmen, and women.

Sustainability

Pianca uses eco-friendly wood sourced from certified forests with controlled harvesting to limit deforestation. Our panels are free from toxic adhesives. We were the first to use water-based gloss lacquers to protect the health of our employees and reduce pollution in the home. Off-cuts are burnt in special furnaces to produce energy, solar panels produce about 1 Megawatt of electric power and our packaging systems are 100% automatic and recyclable so that even Amazon, the American e-commerce company, visited Pianca in 2014 to uncover the secret of its cutting-edge packaging system.

Customer Care

We entrust our products to a selected network of trained retailers who offer the

cliente dalla progettazione al montaggio, garantendo disponibilità e cortesia nel servizio post vendita. Con questi negozi instauriamo un rapporto di partnership, ci confrontiamo quotidianamente per rispondere alle loro esigenze e creare l'arredamento su misura per l'acquirente finale, garantendo una casa di design che risponda ai gusti e alle necessità di chi la abita.

highest guarantees of quality, assistance and courtesy, from planning to delivery and final assembly. We keep in touch with them on a daily basis, to satisfy their needs and create customised furniture for end customers, guaranteeing homes furnished with design products that reflect the tastes and requirements of their householders.

Pianca in the World

Albania	Guernsey	Poland	United States
Andorra	Hong Kong	Portugal	Venezuela
Australia	Hungary	Puerto Rico	Vietnam
Austria	India	Qatar	
Azerbaijan	Indonesia	Romania	
Bahrein	Israel	Russia	
Belgium	Italy	Salvador	
Bielorussia	Kazakhstan	Saint-Barthélemy	
Bulgaria	Korea	San Marino	
Canada	Kuwait	Serbia	
China	Latvia	Seychelles	
Cyprus	Lebanon	Singapore	
Czech Republic	Libya	Slovakia	
Colombia	Lithuania	Slovenia	
Costa Rica	Luxembourg	South Africa	
Croatia	Macedonia	Spain	
Ecuador	Malaysia	Switzerland	
Egypt	Malta	Taiwan	
Estonia	Morocco	Thailand	
France	Mexico	Turkey	
Georgia	Nigeria	Ukraine	
Germany	Netherlands	United Arab Emirates	
Greece	Panama	United Kingdom	

Qualità, funzionalità, versatilità. Valica i confini della camera da letto la collezione di armadi e cabine Pianca, progettata per organizzare qualunque ambiente della casa, area living, cucina e spazi di servizio compresi, anche di ridotte dimensioni. Variegata ed elegante, presenta dettagli ricercati, vasta modularità e lavorazioni su misura, oltre ad un'ampia selezione di finiture da combinare e di attrezzature interne da comporre in base ai propri gusti ed alle proprie esigenze.

^{EN} Quality, functionality and versatility. Pianca's collection of wardrobes and walk-in closets go beyond the boundaries of the bedroom because they have been designed to organise any room in the home including the living room, kitchen and utility rooms, no matter how small. Very varied and elegant, with refined details, a vast range of module sizes and custom-sized units, this collection boasts a wide selection of finishes that can be mixed and matched and interior accessories that can be chosen to suit individual tastes and needs.

PIANCA

Indice

^{EN} Index

Ante incorniciate ^{EN} **Doors with frame**

Vitrum 19, 240
Milano 31, 230
Cornice 45, 222

Ante lineari ^{EN} **Plain doors**

Plana 63, 242
Nastro 75, 232
Icona 87, 226
Tratto 99, 236
Manhattan 109, 228

Ante decorate ^{EN} **Decorated doors**

Raggio 121, 234
Vela 133, 238
Crea 143, 224

Cabine armadio ^{EN} **Walk-in closet**

Anteprima 155, 304
Sipario 183, 300
Island 162, 204, 324
Snake 58, 328
Vista 160, 166, 169, 189, 330

Info Tecniche

^{EN} Technical info

Armadi ^{EN} Wardrobes

Struttura, ^{EN} Structure 210
Finiture interne, ^{EN} Internal finishes 212
Tipologia apertura, ^{EN} Opening types 214
Modularità, ^{EN} Modularity 216
Moduli speciali, ^{EN} Special modules 218

Collezione ante ^{EN} Doors collection

Cornice, Crea, Icona, Manhattan, Milano, Nastro,
Raggio, Tratto, Vela, Vitrum, Plana 221

Moduli speciali ^{EN} Special modules

Stagionale, ^{EN} Seasonal module 248
Per elettrodomestici, ^{EN} For household appliances 249
Con cassetiera esterna, ^{EN} With external drawer units 250
Con vano a giorno, ^{EN} With open element 251
Sovraporta, ^{EN} Over door module 252
Ponte, ^{EN} Bridge module 253
Modulo TV, ^{EN} TV module 254
Angolari, ^{EN} Corners 255
Cabina soffietto, ^{EN} Folding door dressing closet 258
Terminali, ^{EN} Terminal modules 260
Pannelli per modulo centrostanza, ^{EN} Panels for
all-side finished module 262

Attrezzature ^{EN} Accessories

Ripiani, ^{EN} Shelves 266
Divisori interni, ^{EN} Internal partitions 267
Cassettiere, ^{EN} Drawer units 268
Appenderia, ^{EN} Hangers 276
Telai estraibili e accessori, ^{EN} Pull-out frames and
accessories 278
Accessori, ^{EN} Accessories 284
Specchi, ^{EN} Mirrors 286
Illuminazione, ^{EN} Lighting 287
Allestimenti interni, ^{EN} Interior configurations 288

Lavorazioni su misura ^{EN} Made to measure solutions

Altezza, ^{EN} Height 292
Larghezza, ^{EN} Width 293
Profondità, ^{EN} Depth 294
Tamponamenti, ^{EN} Fillers 296

Cabine armadio ^{EN} Walk-in closet

Sipario, Anteprema 300, 304

Complementi cabine ^{EN} Walk-in closet complements

Island, Snake, Vista 324, 328, 330

Indice Armadi e Cabine

EN Wardrobes and Walk-in closet index



Cornice
Photogallery 45
Technical information 222



Crea
Photogallery 143
Technical information 224



Icona
Photogallery 87
Technical information 226



Vela
Photogallery 133
Technical information 238



Vitrum
Photogallery 19
Technical information 240



Vista
Photogallery 160, 166, 169, 189
Technical information 330



Manhattan
Photogallery 109
Technical information 228



Milano
Photogallery 31
Technical information 230



Nastro
Photogallery 75
Technical information 232



Anteprima
Photogallery 155
Technical information 304



Sipario
Photogallery 183
Technical information 300



Plana
Photogallery 63
Technical information 242



Raggio
Photogallery 121
Technical information 234



Tratto
Photogallery 99
Technical information 236

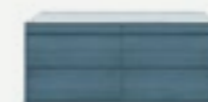

Island
Photogallery 162, 204
Technical information 324



Snake
Photogallery 58
Technical information 328

Ante incorniciate
EN Doors with frame



PIANCA

Sistemi Notte
^{EN} Night Systems

Designer
Pianca Studio

Vitrum

Vitrum
Technical Information
on p. 240

Il vetro rivela, riflette, crea un'affascinante compenetrazione tra interno ed esterno. A modulare questo dialogo è il vetro delle ante, disponibile nella versione Traspirente Extrachiaro, Fumé Traspirente o Satinato, Stop Sol, e nei tre colori dei vetri serigrafati Trama: caratteristiche estetiche differenti per ogni grado di trasparenza. L'anta è serigrafata con un'intrigante cornice nera. Alta e sottile, la maniglia a lama inclinata è realizzata in alluminio anodizzato nero, come il telaio, discreta e maneggevole sia con apertura a battente che scorrevole.

^{EN} Glass reveals, reflects and mingles the inside with the outside in the most fascinating of ways. The mediator of this dialogue is the glass door panel, in Extraclear Transparent, Transparent or Satin Fumé and Stop Sol finishes and in the three colours available for Trama screen-printed glass: different aesthetic features for varying degrees of transparency. The door sports an intriguing, black, screen-printed frame. The long, slim, inclined handle is made from black anodised aluminium matching the frame and is discreet and handy on both hinged and sliding doors.

In questo ambiente: **Vitrum** armadio scorrevole vetro Fumé Traspirente, interno materico Canaletto. **Esse Lounge** poltrona in tessuto Rico 32 con gambe Canaletto.

^{EN} *In this setting:* **Vitrum** sliding door wardrobe in transparent Fumé glass, interior in Canaletto materico. **Esse Lounge** armchair in Rico 32 fabric with Canaletto legs.





Cassettiera materico Canaletto con frontali ed accessori interni in pelle sintetica Elephant. Ripiano in pelle sintetica Elephant con bordo materico Canaletto.

^{EN} Drawer unit in Canaletto materico with fronts and internal accessories in Elephant synthetic leather Shelf covered in Elephant synthetic leather with edging in Canaletto materico.



Vitrum armadio centrostanza con pannello di finitura posteriore Canaletto. **Boiserie** Canaletto con distanziali Titanio, **Rialto** tatami in tessuto Taigal 23 con distanziali Titanio, **Chloé** comodino in tessuto Moritz 52 e laccato opaco Lavagna.

^{EN} **Vitrum** back-finished wardrobe with Canaletto finishing back panel. **Wall panels** Canaletto with Titanio spacers, **Rialto** platform bed in Taigal 23 fabric with Titanio spacers, **Chloé** night table in Moritz 52 fabric and Lavagna matt lacquer.

In questo ambiente: **Vitrum** armadio battente vetro Stopsol, interno e cassettiere laccato opaco Lavagna, schienale materico Gioia di Carrara e **Plana** armadio battente laccato opaco Lavagna. **Eden** poltrona e pouf in pelle Lord 85.

^{EN} *In this setting:* **Vitrum** hinged door wardrobe in Stopsol glass, interior and drawers unit in Lavagna matt lacquer, back panel in Gioia di Carrara materico and **Plana** hinged door wardrobe in Lavagna matt lacquer. **Eden** armchair and ottoman in Lord 85 leather.







PIANCA

Sistemi Notte
^{EN} Night Systems

Designer
Pianca Studio

Milano

Milano
Technical Information
on p. 230

Come in una boutique personale, i propri oggetti e i propri capi di abbigliamento diventano elementi da valorizzare, da esporre con eleganza ed ordine. Le ante in vetro, definite da un telaio verniciato in finitura Canna di Fucile o Silicio enfatizzano ed impreziosiscono le composizioni. Le attrezzature interne a vista dimostrano grande capacità di organizzare con efficacia e raffinatezza lo spazio. Speciale è anche l'apertura a battente delle ante, che può raggiungere un angolo di 180°, con cerniere a perno.

^{EN} Just as if they were arranged in a personal boutique, your objects and garments must be enhanced and exhibited with elegance and order. The glass doors, defined by a Gunmetal Grey or metallized brown frame, set off and add a finishing touch to arrangements. The visible interior accessories show off their great ability to efficiently organise spaces with style. The hinged doors come with special pivot hinges that can open at a 180° angle.

In questo ambiente: **Milano** armadio battente vetro Trama Bronzo con telaio Canna di Fucile, interno materico Borgogna e laccato opaco Ral, **Plana** armadio battente Borgogna. **Eden** pouf capitonné in tessuto Sweet 33, **Mono** tavolo in pelle Lord 89, **Esse** poltrona in tessuto Amalfi 31. Tappeto Apollo Ciliegia.

^{EN} *In this setting:* **Milano** hinged door wardrobe in Trama Bronzo glass with Gunmetal Grey frame, interior in Borgogna materico and Ral matt lacquer, **Plana** hinged door wardrobe in Borgogna. **Eden** tufted ottoman in Sweet 33 fabric, **Mono** table in Lord 89 leather, **Esse** armchair in Amalfi 31 fabric. Carpet Apollo Ciliegia.





Modulo con ante battenti vetro Trama Bronzo, ripiani portascarpe materico Borgogna, schiena laccato opaco Ral e luce a led. Anta **Milano** con telaio Canna di Fucile.



^{EN} Module with hinged doors in Trama Bronzo glass, shoe shelves in Borgogna materico, back panel in Ral matt lacquer and LED light. **Milano** door with Gunmetal Grey frame.



Mono tavolo in pelle Lord 89, **Esse** poltrona in tessuto Amalfi 31. Portagonne estraibile con telaio Manganese e frontale materico Borgogna.

^{EN} **Mono** table in Lord 89 leather, **Esse** armchair in Amalfi 31 fabric. Extractible skirt hanger with Manganese frame and front in Borgogna materico.

In questo ambiente: **Milano** armadio battente vetro trasparente Extrachiaro, con telaio Canna di Fucile, interno materico Borgogna e laccato opaco Cioccolato, luce led. **Dioniso** letto Rovere Grigio e pelle Softy 64, **Dedalo** comodino Rovere Grigio con top in pietra Multicolor. Tappeto Teseo Talpa.

^{EN} *In this setting:* **Milano** hinged door wardrobe in Extra clear transparent glass, with Gunmetal Grey frame, interior in Borgogna materico and Cioccolato matt lacquered, LED light. **Dioniso** bed in Rovere Grigio and Softy 64 leather, **Dedalo** night table in Rovere Grigio and top in Multicolor slate. Carpet Teseo Talpa.





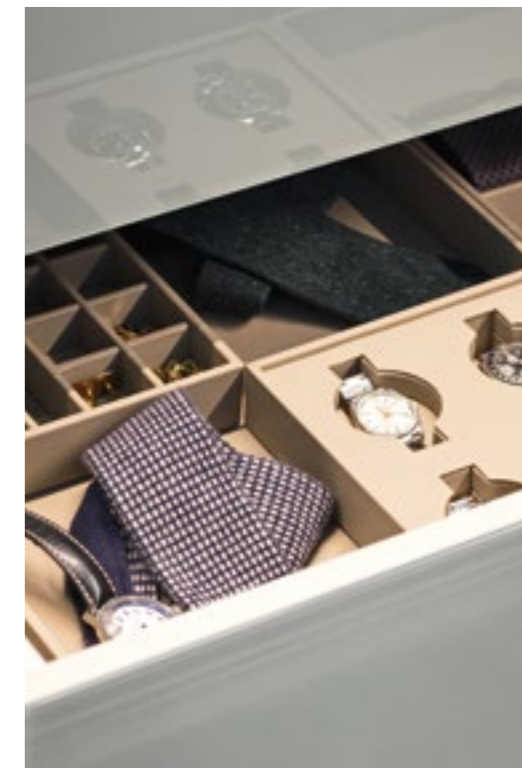

In questo ambiente: Milano armadio con ripiani e cassettiere laccato opaco Cioccolato e schienale in materico Borgogna. Accessori per interno cassetto in pelle sintetica Creta.

^{EN} *In this setting: Milano* wardrobe with shelves and drawer units in Cioccolato matt lacquer and back panel in Borgogna materico. Accessories for drawer interior in Creta synthetic leather.

PIANCA

Sistemi Notte
EN Night Systems

Designer
Pianca Studio

Cornice

Cornice
Technical Information
on p. 222

Il tratto sottile e continuo del telaio disegna un profilo discreto ed essenziale. In alluminio laccato o anodizzato nero, ritma la successione di elementi verticali, oppure tende a mimetizzarsi se coordinato alla superficie delle ante, disponibili in vetro laccato, specchio, essenza, materico, pelle sintetica e laccate. Longilinea e leggermente angolata, la maniglia nasce come naturale continuazione del telaio, garantendo un'immagine elegante e lineare, e un'ottima prensilità per ogni tipologia di anta, a battente, scorrevole o complanare.

EN The slim, uninterrupted line of the frame draws a discreet and minimal outline. In lacquered or black anodized aluminium, it punctuates the run of vertical modules or tends to blend in when coordinated with the surface finish of the doors available in lacquered glass, mirror, wood and textured finishes as well as man-made leather and matt or gloss lacquers. Long and slightly angled, the handle is designed to form a line that carries on from the frame, giving the door an elegant, linear appeal and offering an excellent grip to any type of hinged, sliding and flush sliding door.

In questo ambiente: **Cornice** armadio battente in pelle sintetica Talpa, interno materico Borgogna, cassettera con frontali oblò vetro Fumé. **Oplà** poltrona in tessuto Sweet 33.

EN *In this setting:* **Cornice** hinged door wardrobe in Talpa synthetic leather interior in Borgogna materico, drawer unit with Fumé glass fronts. **Oplà** armchair in Sweet 33 fabric.





Cornice armadio in pelle sintetica Talpa con modulo terminale a scrigno, ripiani materico Borgogna e luce led verticale.

^{EN} **Cornice** wardrobe in Talpa synthetic leather with terminal module with L-shaped opening, shelves in Borgogna materico and vertical LED light.

In questo ambiente: **Cornice** armadio scorrevole vetro Metallizzato Bronzo, interno materico Perlage Terra e ripiani vetro Fumé. **Cubo** pouf in pelle Polo 18, **Mono** tavolo Corten, **Gamma** sedia in tessuto Gaucho 51 con basamento tubolare Borgogna, **People** comò Borgogna con distanziali Bronzo.

^{EN} *In this setting:* **Cornice** sliding door wardrobe in glass Metallizzato Bronzo, interior in Perlage Terra materico and shelves in Fumé glass. **Cubo** ottoman in Polo 18 leather, **Mono** table in Corten, **Gamma** chair in Gaucho 51 fabric with tubular base in Borgogna, **People** dresser in Borgogna with Bronzo spacers.





In questo ambiente: **Cornice** armadio complanare specchio Piombo, interno laccato opaco Melograno. **Esse Lounge** poltrona in tessuto Positano 51.

In this setting: **Cornice** flush-sliding door wardrobe in Piombo mirror, interior in Melograno matt lacquer. **Esse Lounge** armchair in Positano 51 fabric.





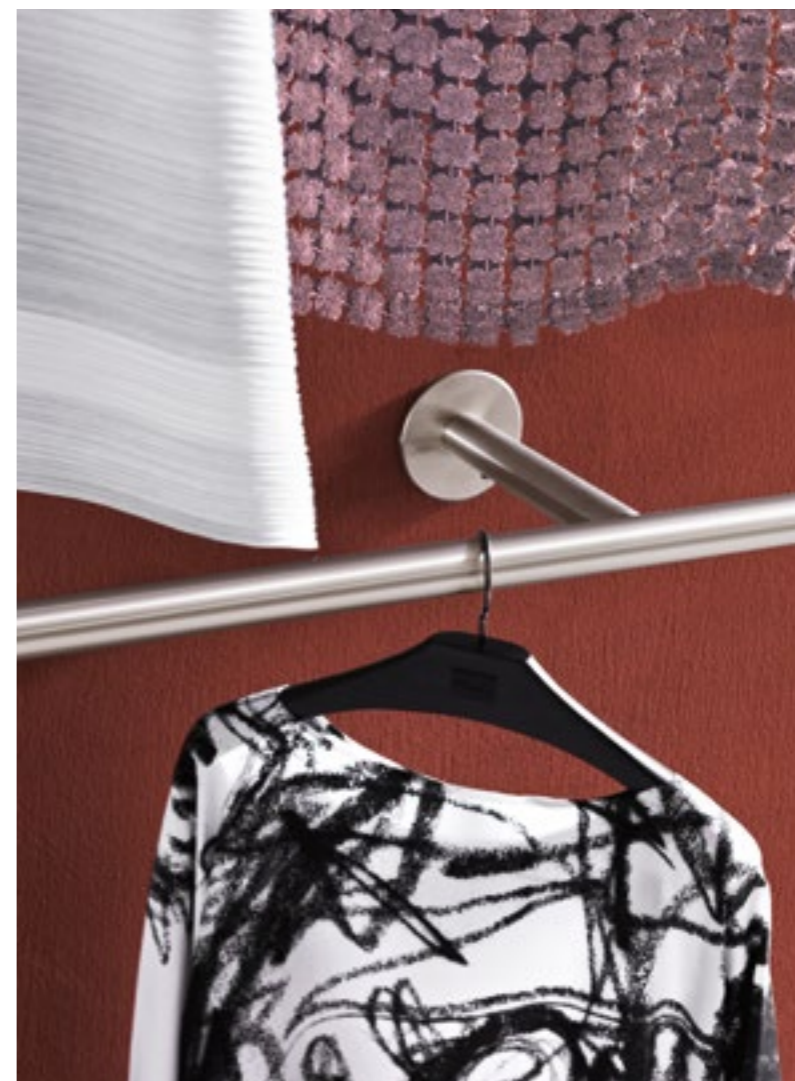

Snake composizione appendiabiti a parete in acciaio spazzolato. Aste e connessioni a passo 14 cm danno la possibilità di creare qualsiasi disegno a parete. Tappeto Apollo Ciliegia.

EN Snake wall composition in sanded steel. Beams and connections with their 14 cm pace allow to create any kind of wall composition. Carpet Apollo Ciliegia.

Ante lineari
EN Plain doors



PIANCA

Sistemi Notte
EN Night Systems

Designer
Pianca Studio

Plana

Plana
Technical Information
on p. 242

Essenzialità e versatilità si traducono in libertà di personalizzare ed arredare. Ante semplici, lineari, disponibili laccate, in essenza o materico, completate da una vasta scelta di maniglie da abbinare all'apertura, a battente, scorrevole o complanare. Risolvere soluzioni è nell'indole di Plana, che mette a disposizione anche moduli speciali: stagionale, sovrapporta, ponte con scrittoio o con tv, cassetiera esterna, per elettrodomestici, con moduli a giorno, terminale, cabina a soffietto. A richiesta anche lavorazioni su misura, per inserire la struttura in qualsiasi spazio.

EN Minimalism and versatility become freedom to customise and furnish. Simple, linear doors are available lacquered, in wood or textured, completed by a vast range of handles to pair with hinged, sliding and flush sliding doors. Problem-solving comes naturally to Plana that is also available in special modules: four-season units, over door modules, bridging modules with a desk or TV, modules with external drawer units, household appliances, with open modules, terminal modules and walk-in closets with folding doors. Custom-sized modules that can be fitted in any kind of space are also available.

In questo ambiente: **Plana** armadio complanare materico Corsica e maniglia Rame. **Esse Lounge** poltrona in tessuto Moritz 51 con gambe laccato opaco Lavagna.

EN *In this setting:* **Plana** flush-sliding door wardrobe in Corsica materico and Rame handle. **Esse Lounge** armchair in Moritz 51 fabric with legs in Lavagna matt lacquer.

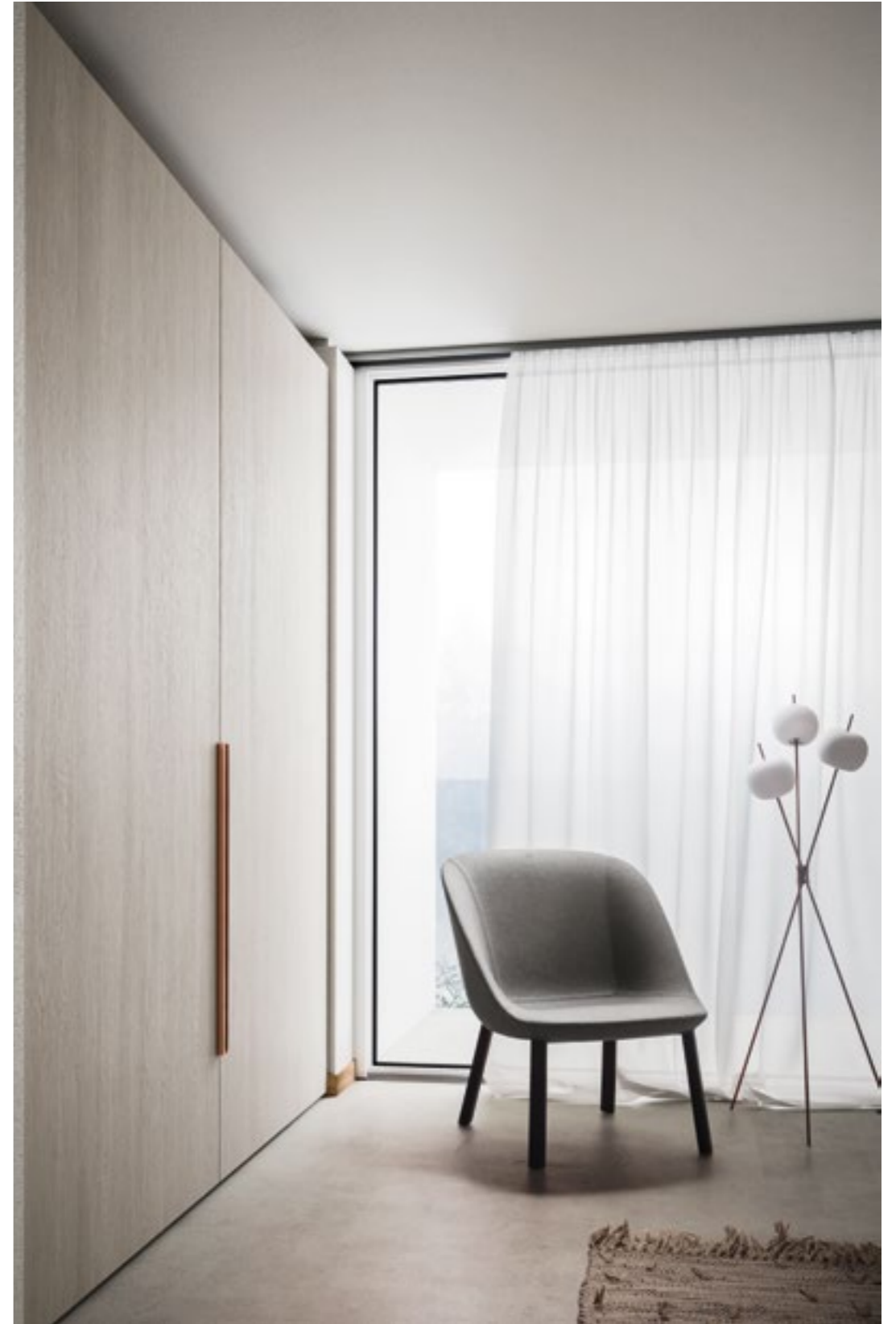

In questo ambiente: **Plana** armadio battente Canaletto con apertura push-pull e moduli a giorno laccato opaco Nuvola. **Calatea** poltrona in pelle Softy 62 con gambe laccato opaco Lavagna, elemento **Spazio** in laccato opaco Lavagna.

^{EN} *In this setting:* **Plana** hinged door wardrobe in Canaletto, with push pull opening and open modules in Nuvola matt lacquer. **Calatea** armchair in Softy 62 leather with legs in Lavagna matt lacquer, **Spazio** element in Lavagna matt lacquer.





In questo ambiente: **Plana** armadio scorrevole laccato lucido Cappuccino, interno materico Borgogna. **Trama Intreccio** letto in pelle Vintage 33, **Servogiro** tavolino laccato opaco Lavagna. Tappeto Teseo Terra.

^{EN} *In this setting:* **Plana** sliding door wardrobe in Cappuccino high-gloss lacquer, interior in Borgogna materico. **Trama Intreccio** bed in Vintage 33 leather, **Servogiro** side table in Lavagna matt lacquer. Carpet Teseo Terra.





PIANCA

Sistemi Notte
^{EN} Night Systems

Designer
Pianca Studio

Nastro

Nastro
Technical Information
on p. 232

Lo stile sobrio e delicato della semplicità incontra la massima possibilità di espressione e personalizzazione. Per soddisfare qualunque esigenza estetica e funzionale, Nastro offre una vasta gamma di finiture e soluzioni speciali: cassettera esterna, modulo a ponte, sovrapporta, tv, terminale a giorno oltre alle lavorazioni su misura. Incassate nelle ante, le maniglie in alluminio a tutta altezza delineano gole dai colori laccati o dalle brillanti finiture metalliche.

^{EN} The understated and delicate style of simplicity meets the ultimate in expressiveness and customisation. Nastro offers a vast range of finishes and special solutions to satisfy any aesthetic or functional request: external drawer unit module, bridging module, unit installed above doors, TV unit, open end unit as well as custom-sized solutions. Recessed in the doors, the aluminium, full-height handles draw channels in lacquered colours or in shiny metal finishes.

In questo ambiente: **Nastro** armadio battente con cassetti esterni e modulo ponte Borgogna, maniglia Oro. **Gamma** sedia in tessuto Velvet 44 con traliccio Oro.

^{EN} *In this setting:* **Nastro** hinged door wardrobe with external drawers and Borgogna bridge module, Oro handle. **Gamma** chair in Velvet 44 fabric with Oro pylon base.





Nastro armadio con modulo ponte Borgogna e **Ala** scrittoio.
Gamma sedia in tessuto Velvet 44 con traliccio Oro.

^{EN} **Nastro** wardrobe with Borgogna bridge module and **Ala** desk.
Gamma chair in Velvet 44 fabric with Oro pylon base.

In questo ambiente: **Nastro** armadio scorrevole con terminale a giorno attrezzato con ripiani laccato opaco Seta e asta appendiabiti Manganese. **Abaco** tavolino Rame.

EN In this setting: **Nastro** sliding door wardrobe with open terminal module equipped with shelves in Seta matt lacquer and hanger in Manganese. **Abaco** side table in Rame.





Nastro armadio con interno laccato opaco Seta, elemento a T, luce led orizzontale. Terminale a giorno con asta appendiabiti Manganese.

^{EN} **Nastro** wardrobe with interior in Seta matt lacquer, T-shaped element, horizontal LED light. Open terminal module with Manganese hanger.

In questo ambiente: **Nastro** armadio complanare vetro laccato opaco Lavagna, interno laccato opaco Argilla. **Rialto Large** letto in pelle Nabuk 41 e distanziali Borgogna, **Haik** tavolino Argento.

^{EN} *In this setting:* **Nastro** flush-sliding door wardrobe in Lavagna matt lacquered glass, interior in Argilla matt lacquer. **Rialto Large** bed in Nabuk 41 leather and Borgogna spacers, **Haik** side table in Argento.





PIANCA

Sistemi Notte
EN Night Systems

Designer
Pianca Studio

Icona

Icona
Technical Information
on p. 226

Design lineare e versatile dai dettagli sofisticati. Icona si veste di personalità attraverso il connubio tra sobrietà ed espressività. Incassata nel pannello in legno, orizzontale o verticale, la maniglia rappresenta un elemento distintivo e raffinato, da personalizzare in base al proprio gusto: con colori laccati vivaci o più neutri, con finiture metalliche classiche o più eccentriche. Laccate, in essenza o materico, le ante hanno apertura a battente, scorrevole o complanare.

EN A linear, versatile design sporting sophisticated details. Icona conveys its personality by pairing understated beauty with expressiveness. The handle - recessed either horizontally or vertically into the wood panel - is a distinctive, refined accent that can be customised to suit individual tastes: choose from bright or more neutral lacquer colours, with classic metallic or more eccentric finishes. Lacquered, in wood or with a textured finish, the doors come in the hinged, sliding and flush sliding versions.

In questo ambiente: **Icona** armadio scorrevole Canaletto e maniglia orizzontale Rame. **Calatea** poltrona in pelle Softy 62 con gambe laccato opaco Lavagna.

EN *In this setting:* **Icona** sliding door wardrobe in Canaletto and horizontal handle in Rame. **Calatea** armchair in Softy 62 leather with legs in Lavagna matt lacquer.



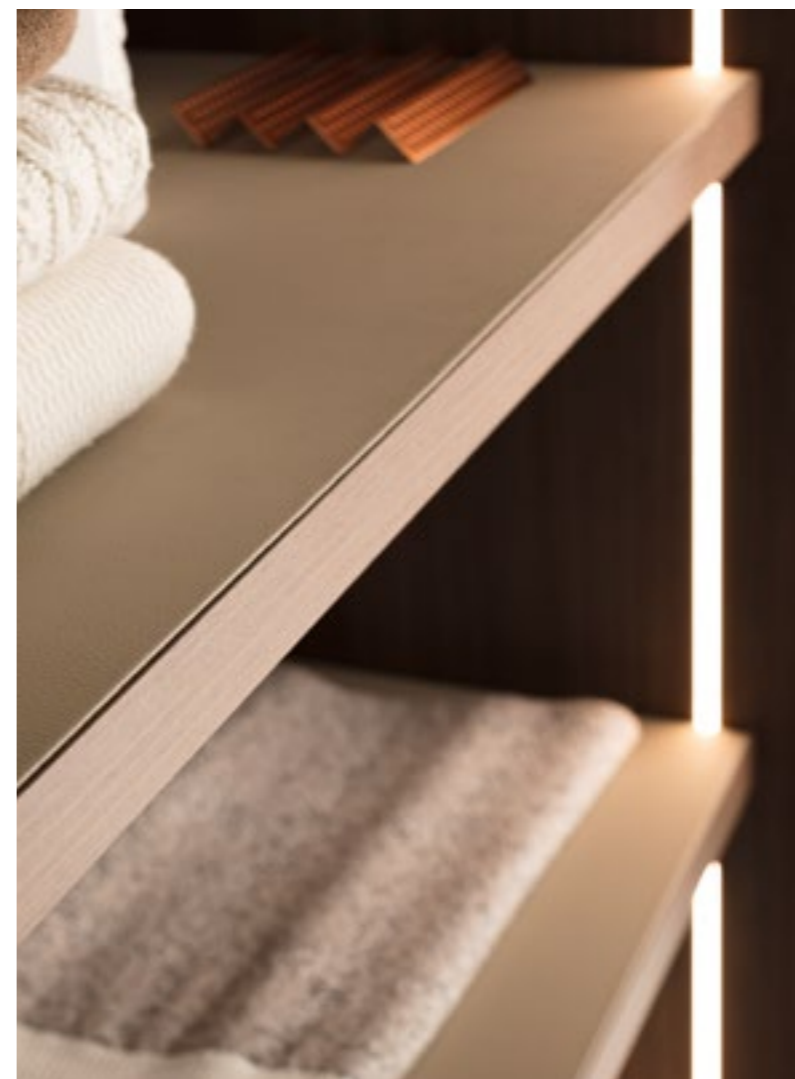

Armadio scorrevole con interno materico Canaletto e ripiani in pelle sintetica Creta con bordo materico Canaletto, luce led verticale.

^{EN} Sliding door wardrobe with interior in Canaletto materico and shelves in Creta synthetic leather with edging in Canaletto materico, vertical LED light.

In questo ambiente: **Icona** armadio battente con modulo angolo opposto laccato opaco Nuvola, maniglia verticale laccato opaco Nuvola. **Calatea** poltrona in pelle Softy 62, **Duetto** tavolino Bronzo.

^{EN} *In this setting:* **Icona** hinged door wardrobe with opposite corner module in Nuvola matt lacquer, vertical handle in Nuvola matt lacquer. **Calatea** armchair in Softy 62 leather, **Duetto** side table in Bronzo.



In questo ambiente: **Icona** armadio complanare laccato lucido Piombo con maniglia orizzontale Titanio, interno laccato opaco Piombo, schienali materico Gioia di Carrara opaco. **Servogiro** tavolino Rovere Cenere con struttura laccato Piombo, **Delano** pouf in tessuto Taigal 51, **Filo Capitonné** letto in pelle Polo 18 con piede laccato opaco Piombo.

^{EN} *In this setting:* **Icona** flush-sliding door wardrobe in Piombo high gloss lacquer with horizontal handle in Titanio, interior in Piombo matt lacquer, back panels in matt Gioia di Carrara materico. **Servogiro** side table in Rovere Cenere with structure in Piombo matt lacquer, **Delano** ottoman in Taigal 51 fabric, **Filo Capitonné** bed in Polo 18 leather with feet in Piombo matt lacquer.





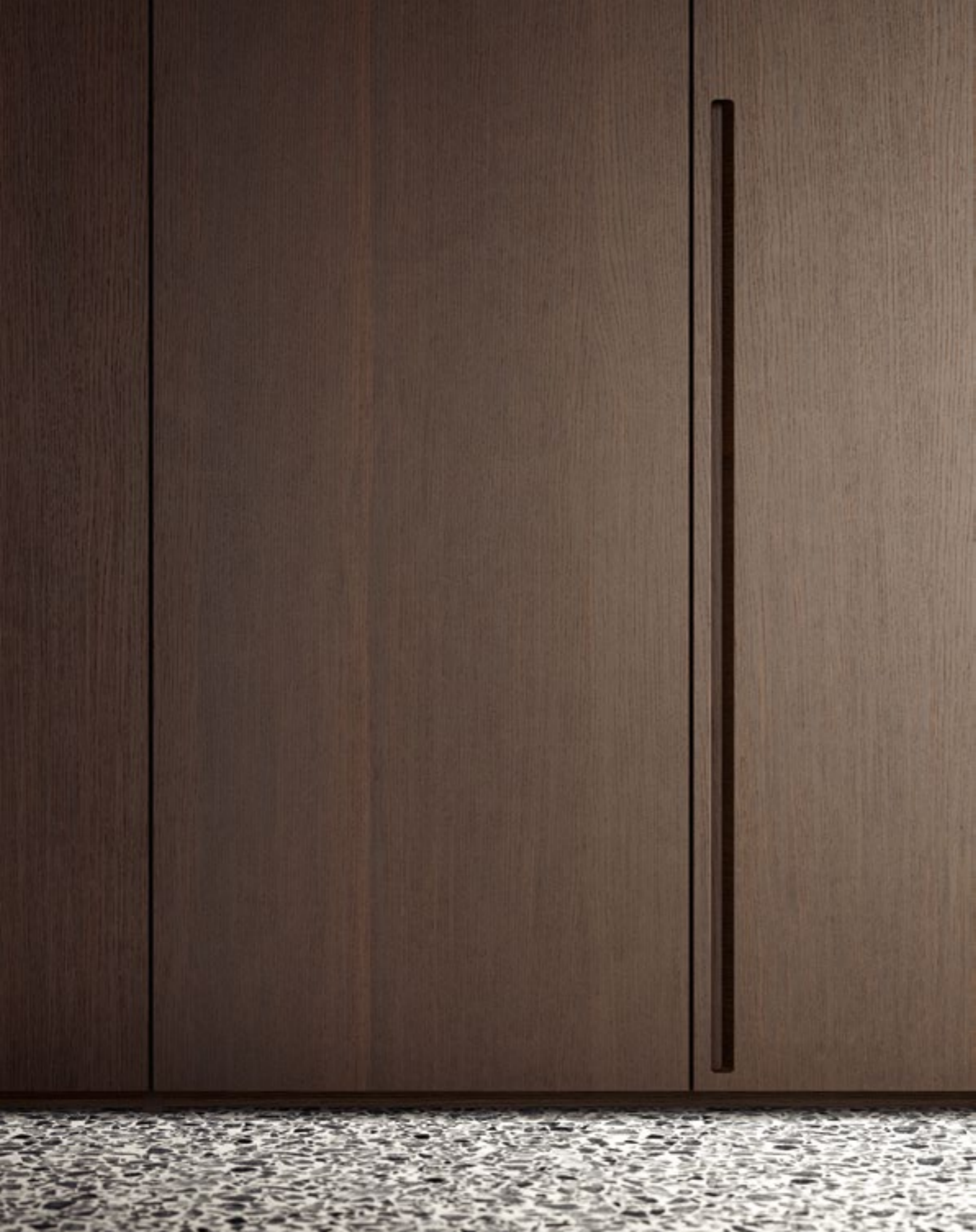

PIANCA

Sistemi Notte
EN Night Systems

Designer
Pianca Studio

Tratto

Tratto
Technical Information
on p. 236

Una convivenza imbattibile quella tra minimalismo estetico e funzionalità. È una semplicità che conquista per la sua coerenza e la forza della sua essenzialità. Tratto integra e fonde gli elementi dell'anta, ricavando la maniglia all'interno del pannello di legno. Scavata in senso verticale e prossima al bordo dell'anta, garantisce una presa sicura sia nella versione con apertura a battente che scorrevole. Uniformità materica, anche nelle finiture, a scelta tra i laccati e le essenze della collezione.

EN Aesthetic minimalism and functionality are an unbeatable combo. This wardrobe's success lies in its consistent simplicity and in the power of its minimal lines. Tratto integrates and blends the door parts while carving the handle out of the panel. Vertically recessed near the edge of the door, it offers a sound grip on both hinged and sliding doors. Surfaces feature uniform materials available in all the lacquers and wood types of the collection.

In questo ambiente: **Tratto** armadio battente e cabina angolare con ante a soffietto Borgogna. **Dedalo** comodino Borgogna, **Fushimi** letto Borgogna e pelle Nabuk 41. Tappeto Ulisse Madera.

EN *In this setting:* **Tratto** hinged door wardrobe and corner walk-in closet with Borgogna folding doors. **Dedalo** night table Borgogna, **Fushimi** bed in Borgogna and Nabuk 41 leather. Carpet Ulisse Madera.





Cabina angolare con ante a soffietto, ripiani materico Borgogna, schienale materico Emperador, cassettera con frontali oblò vetro Fumé, luce led orizzontale.

^{EN} Corner walk-in closet with folding doors, shelves in Borgogna materico, back panel in Emperador materico, drawer unit with fronts in Fumé glass, horizontal LED light.

In questo ambiente: **Tratto** armadio scorrevole laccato lucido Seta, interno materico Perlage Terra. **Calatea** poltrone in tessuto Moritz 11 con seduta in Velvet 31 e con stampa esclusiva. Tappeto Apollo Sale e Pepe.

^{EN} *In this setting:* **Tratto** sliding door wardrobe in Seta high gloss lacquer, interior in Perlage Terra materico. **Calatea** armchairs in Moritz 11 fabric with seat cushion in Velvet 31 fabric and with Calatea exclusive design. Carpet Apollo Sale e Pepe.







PIANCA

Sistemi Notte
EN Night Systems

Designer
Pianca Studio

Manhattan

Manhattan
Technical Information
on p. 228

Design fresco e moderno, ispirato ad un'estetica minimale dalle linee contemporanee. Ricorda un affusolato profilo alare la sofisticata geometria della maniglia, costituita da un taglio verticale lungo l'anta e da una parte interna personalizzabile nelle finiture laccate, metallizzate e nelle essenze. Ancora più vasta la possibilità di scelta per le ante, disponibili in vetro, specchio, essenza e laccate, da coordinare o meno con la maniglia, per un effetto tono su tono oppure in contrasto.

EN A fresh, modern design inspired by the contemporary lines of minimal aesthetics. The sophisticated shape of the handle - consisting of a vertical groove in the door edge and of an inner surface that can be customised in lacquered, metallic and wood finishes - is reminiscent of the tapered profile of a wing. The doors come in an even wider range of finishes, available in glass, mirror, wood and lacquer, coordinated with or differing from the handle for a tone-on-tone or contrasting effect.

In questo ambiente: **Manhattan** armadio battente laccato opaco Seta con modulo terminale a giorno e interno laccato opaco Seta, maniglia Rame.

EN *In this setting:* **Manhattan** hinged door wardrobe in Seta matt lacquer with open terminal module, interior in Seta matt lacquer, Rame handle.





Modulo terminale a giorno con ripiani laccato opaco Seta.
Dioniso letto Rovere Naturale e tessuto Gaucho 41.
Portapantaloni e vassoio estraibili con telaio Manganese e frontale materico Seta.

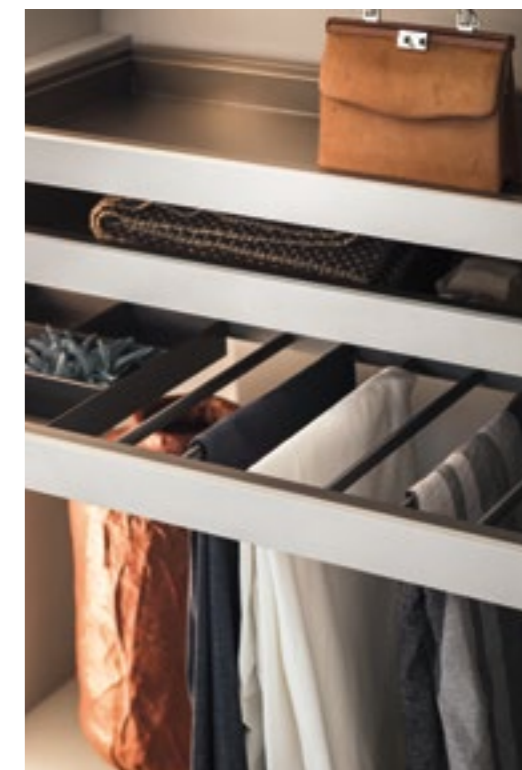

^{EN} Open terminal module with shelves in Seta matt lacquer.
Dioniso bed in Rovere Naturale and Gaucho 41 fabric.
Extractible trousers hanger and tray with Manganese frame and front in Seta materico.

In questo ambiente: **Manhattan** armadio scorrevole laccato lucido Cappuccino e maniglia Titanio.

EN In this setting: **Manhattan** sliding door wardrobe in Cappuccino high gloss lacquer and Titanio handle.





Ante decorate
EN Decorated doors



PIANCA

Sistemi Notte
^{EN} Night Systems

Designer
Pianca Studio

Raggio

Raggio
Technical Information
on p. 234

Lussuosa, eccentrica ed elegante, la decorazione diventa protagonista. A catturare lo sguardo sono le incisioni verticali che percorrono la superficie dell'anta, alternandosi come raggi discontinui e disegnando dinamici motivi paralleli. Lucide o opache, impreziosiscono i vetri o gli specchi delle ante. Le maniglie sono ricavate a tutta altezza all'interno dell'anta e sono realizzate in alluminio laccato o con finitura metallizzata.

^{EN} Lush, eccentric and elegant, embellishments steal the show. Vertical incisions run across the surface of the door, alternating like discontinuous rays of light that sketch dynamic, parallel lines. Gloss or matt, they beautify the glass or mirrored door surfaces. The handles run along the whole height of the inner door edge and come in a lacquered aluminium or metallic finish.

In questo ambiente: **Raggio** armadio battente a specchio Inciso Piombo e maniglia Bronzo, modulo TV con cassetti Borgogna. **Servogiro** tavolino laccato opaco Piombo con struttura laccato opaco Lavagna.

^{EN} *In this setting:* **Raggio** hinged door wardrobe in Piombo Inciso mirror and Bronzo handle, TV module with drawers in Borgogna. **Servogiro** side table in Piombo matt lacquer with structure in Lavagna matt lacquer.



In questo ambiente: **Raggio** armadio complanare a specchio Inciso Fumé e maniglia laccato opaco Lavagna, interno materico Borgogna. **Servogiro** tavolino Borgogna con struttura Bronzo, **Delano** pouf in tessuto Taigal 51.

^{EN} *In this setting:* **Raggio** flush-sliding door wardrobe in Inciso Fumé glass and handle in Lavagna matt lacquer, interior in Borgogna materico. **Servogiro** side table in Borgogna with Bronzo structure, **Delano** ottoman in Taigal 51 fabric.





In questo ambiente: **Raggio** armadio scorrevole vetro laccato opaco Bianco con incisione in contrasto. **Isotta** poltrona laccato opaco e cuoio Bianco.

EN In this setting: **Raggio** sliding door wardrobe in Bianco matt lacquered glass with contrasting carving. **Isotta** armchair in Bianco matt lacquer and leather.





Raggio armadio vetro laccato opaco Bianco con maniglia laccato opaco Bianco. Dettaglio vetro laccato opaco con incisione lucida.

^{EN} **Raggio** wardrobe with Bianco matt lacquered glass and handle. Detail of matt lacquered glass and high gloss carving.



PIANCA

Sistemi Notte
EN Night Systems

Designer
Pianca Studio

Vela

Vela
Technical Information
on p. 238

Armonia ed eleganza, scandite da contrasti materici. L'estetica di Vela inverte il classico sviluppo in altezza e propone nuovi equilibri visivi. Tre le fasce orizzontali che vengono a delinearsi grazie ai pannelli centrali che interrompono la continuità delle ante, scorrevoli o complanari. Il contrasto tra le fasce è determinato dalla scelta delle finiture, disponibili tra i laccati e le essenze. La maniglia verticale, ricavata in corrispondenza del pannello centrale, è realizzabile laccata o essenza.

EN Harmony and elegance are punctuated by contrasting materials. Vela's design inverts the typical vertical development of the door and suggests new visual effects. The central panels that interrupt the finish of sliding or flush sliding doors create three, horizontal bands. A contrast is achieved by choosing different lacquered or wood finishes for these bands. The vertical handle, carved out of the central panel, is available lacquered or in wood.

In questo ambiente: **Vela** armadio complanare laccato opaco Nuvola con fascia centrale Rovere Naturale. **Calatea** poltrona in tessuto Velvet 11 con piede Rovere Naturale. Tappeto Ulisse Sabbia.

EN *In this setting:* **Vela** flush-sliding door wardrobe in Nuvola matt lacquer with central panel in Rovere Naturale. **Calatea** armchair in Velvet 11 fabric and feet in Rovere Naturale. Carpet Ulisse Sabbia.



In questo ambiente: **Vela** armadio scorrevole laccato lucido Lavagna, fascia centrale laccato opaco Lavagna, interno materico Perlage Conchiglia. **Esse Lounge** poltrona in pelle Nabuk 44 con gambe Rovere Grigio, **Dedalo** comò Rovere Grigio.

^{EN} *In this setting:* **Vela** sliding door wardrobe in Lavagna high gloss lacquer, central panel in Lavagna matt lacquer, interior in Perlage Conchiglia materico. **Esse Lounge** armchair in Nabuk 44 leather with legs in Rovere Grigio, **Dedalo** dresser in Rovere Grigio.







Interno armadio con ripiani e cassettera materico Perlage Conchiglia, aste appendiabiti Manganese e luce led orizzontale.

^{EN} Wardrobe interior with shelves and drawer unit in Perlage Conchiglia materico, Manganese hangers and horizontal LED light.



PIANCA

Sistemi Notte
EN Night Systems

Designer
Pianca Studio

Crea

Crea
Technical Information
on p. 224

Design ricercato dallo stile raffinato ed eccentrico. Il motivo geometrico delle ante crea un ritmo di superfici vetrate lucide ed opache: rettangoli di varie dimensioni e proporzioni che si alternano e si accostano trovando radici in un linguaggio artistico moderno. Di grande impatto grafico è la maniglia, che si configura come un taglio orizzontale che rafforza la bellezza della composizione. Può essere laccata opaca o in essenza ed è ricavata all'interno delle ante, disponibili scorrevoli o complanari.

EN A refined design with a stylish, eccentric appeal. The geometric door decor offers a juxtaposition of gloss and matt glass surfaces. Various-sized rectangles in different proportions stem from a modern artistic language. The handle has a strong graphic impact, cutting across the doors in a horizontal line that enhances the beauty of the composition. Available matt lacquered or in wood, it is recessed inside the panel of sliding or flush sliding doors.

In questo ambiente: **Crea** armadio complanare in vetro opaco e lucido Lavagna. **Atlante** comò con top e profili laccato opaco Lavagna, struttura e frontali laccato lucido Lavagna. Tappeto Teseo Talpa.

EN *In this setting:* **Crea** flush-sliding door wardrobe in Lavagna matt and glossy lacquered glass. **Atlante** dresser with top and side trims in Lavagna matt lacquer, structure and fronts in Lavagna high gloss lacquer. Carpet Teseo Talpa.



In questo ambiente: **Crea** armadio scorrevole con ante vetro laccato opaco e lucido Argilla, interno materico Perlage Terra, ripiani vetro Fumé, maniglia Borgogna.

^{EN} *In this setting:* **Crea** sliding door wardrobe with doors in Argilla matt and glossy lacquered glass, interior in Perlage Terra materico, shelves in Fumé glass, Borgogna handle.





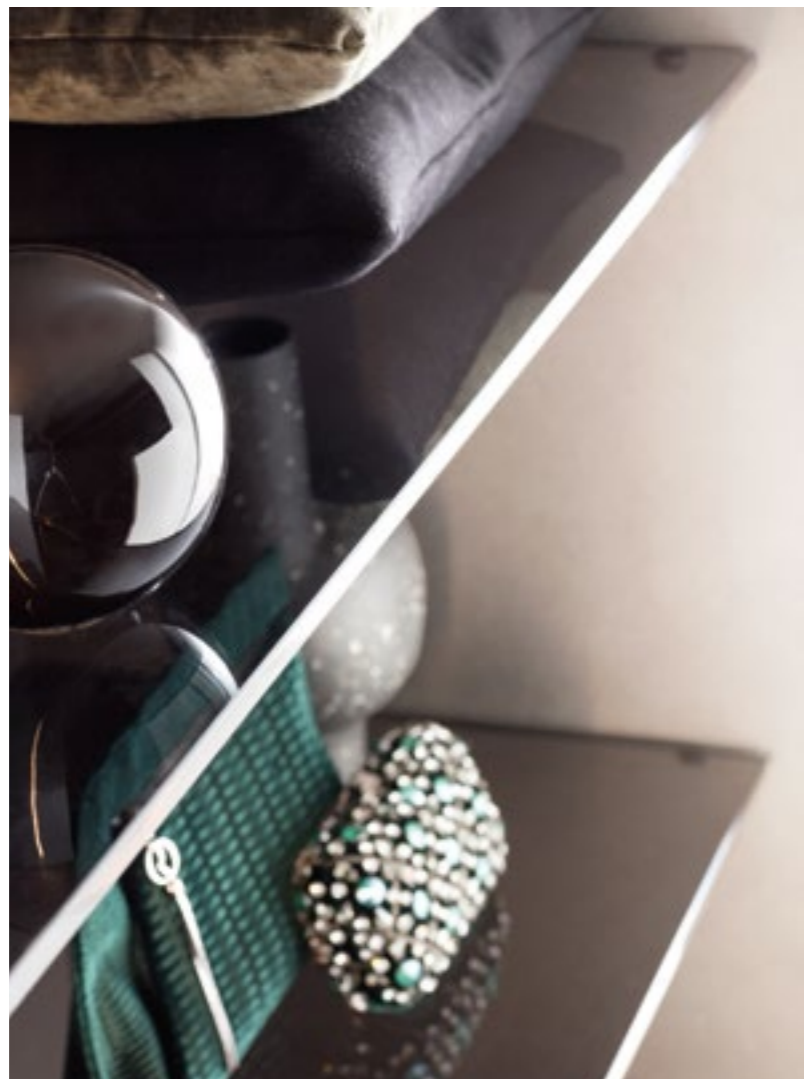

Ripiani vetro Fumè, interno Perlage Terra. Cassettiera materico Perlage Terra con fondo in pelle sintetica Creta, girocassetto materico Argento.

^{EN} Shelves in Fumé glass, interior in Perlage Terra. Drawer unit in Perlage Terra materico with bottom of drawers in Creta synthetic leather, Argento materico drawer structure.

Cabine armadio
EN Walk-in closet



PIANCA

Sistemi Notte
EN Night Systems

Designer
Pianca Studio

Anteprima

Anteprima
Technical Information
on p. 304

Scegliere quali capi di abbigliamento indossare, che scarpe ed accessori abbinare è un rito che compiamo nella quotidianità e nelle occasioni speciali. Anteprima nasce per accompagnare ed ispirare i nostri gesti. Soluzioni pratiche ed affascinanti, dotate della massima libertà compositiva ed ampiamente personalizzabili nelle finiture, rispondono alle più esigenti richieste. Disponibile con o senza schienali, la struttura può essere completata con elementi modulari di ogni genere, come ripiani, cassettiere, raster pensili, appenderie.

^{EN} Every day of our lives – as well as on special occasions – we repeat the ritual of choosing what clothes to wear and which shoes and accessories to use with them. Anteprima has been designed to accompany and inspire our choices. Practical, fascinating elements allow unsurpassable freedom of arrangement and can be customised in a wide range of finishes to meet the most demanding requests. Available with or without back panels, the structure can be completed by lots of different modular elements such as shelves, drawer units, suspended cubbies and hangers.

In questo ambiente: **Anteprima** cabina con schienali materico Borgogna, pelle sintetica Elephant e specchio Piombo; attrezzata con ripiani telaio Manganese e vetro Fumé, portascarpe materico Borgogna, telai estraibili con frontale laccato opaco Argilla. **Island** con ripiani materico Borgogna e teca portaoggetti in vetro trasparente. **Cubo** pouf in tessuto Velvet 41.

^{EN} *In this setting:* **Anteprima** walk-in closet with backs in Borgogna materico, Elephant synthetic leather and Piombo mirror; equipped with shelves in Fumé glass and Manganese frame, shoe shelf in Borgogna materico, extractible frames with fronts in Argilla matt lacquer. **Island** with shelves in Borgogna materico and cover in transparent glass. **Cubo** ottoman in Velvet 41 fabric.





Ripiano portascarpe materico Borgogna e battitacco Manganese. Telaio con vassoio Manganese e frontale laccato opaco Argilla.

Nella pagina seguente: **Anteprima** e **Sipario** cabina con telaio, **Vista** sistema di chiusura con ante Crystal, **Eden** pouf in tessuto Velvet 41, **Abaco** tavolino in Titanio.



^{EN} Shoe shelf in Borgogna materico and Manganese central insert. Frame with Manganese tray and front in Argilla matt lacquer.

On the following page: **Anteprima** and **Sipario** walk-in closet with frame, **Vista** door system with Crystal doors, **Eden** ottoman in Velvet 41 fabric, **Abaco** side table in Titanio.





Island modulo singolo con ripiani materico Borgogna, vassoi con griglia in pelle sintetica Elephant e teca in vetro trasparente.

^{EN} **Island** single module with shelves in Borgogna materico, trays with grid in Elephant synthetic leather and top in transparent glass.

In questo ambiente: Anteprima cabina senza schienali con montanti Manganese, attrezzata con ripiani, cassetiera e pedane laccato opaco Seta. **Vista** sistema di chiusura ad angolo con binario a soffitto con pannelli fissi e ante scorrevoli Plana lucido Seta, maniglia Rame.

^{EN} *In this setting: Anteprima* walk-in closet without back panels and Manganese vertical supports, equipped with shelves, drawer unit and platforms in Seta matt lacquer. **Vista** door corner system with ceiling mounted rail, with fixed panels and sliding Plana doors in Seta high gloss lacquer, Rame handle.





In questo ambiente: **Vista** sistema di chiusura con binario incassato, pannelli fissi e anta Crystal in vetro serigrafato Trama Argento. **Anteprima** cabina con schienali. **Delano** pouf in tessuto Sweet 44, **Geometrika** specchio rettangolare.

^{EN} *In this setting:* **Vista** door system with recessed rail, fixed panels and Crystal door in Trama Argento glass. **Anteprima** walk-in closet with backs. **Delano** ottoman in Sweet 44 fabric, **Geometrika** rectangular mirror.





Anteprima cabina materico Canaletto con schienale specchio Piombo, aste appendiabiti Manganese, portascarpe, telai estraibili, cassettiere, raster e pedane.

Anteprima walk-in closet in Canaletto materico with back panels in Piombo mirror, Manganese hangers, shoe shelves, extractible trays, drawer units, cubbies and platforms.

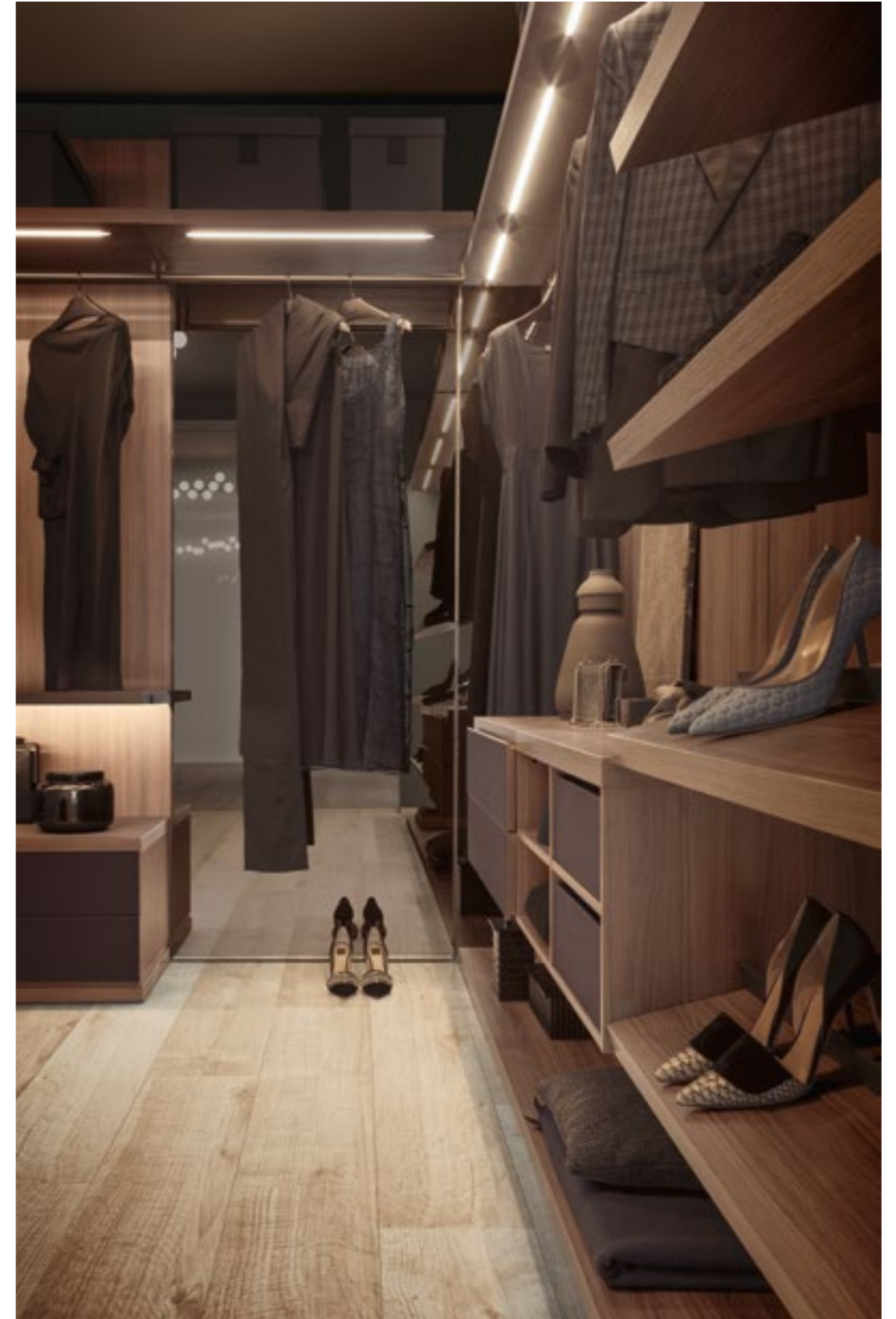





Schienale in materico Grafite opaco e Canaletto, pedana in materico Canaletto, cassettera con frontali in pelle sintetica Talpa.

^{EN} Back panel in Grafite matt and Canaletto materico, platform in Canaletto materico, drawer unit with fronts in Talpa synthetic leather.





Raster materico Canaletto con contenitore in pelle sintetica Elephant. Cassetto con frontale, top e accessori in pelle sintetica Elephant.

^{EN} Cubbies in Canaletto materico with storage in Elephant synthetic leather. Drawer with front, top and accessories in Elephant synthetic leather.



PIANCA

Sistemi Notte
EN Night Systems

Designer
Pianca Studio

Sipario

Sipario
Technical Information
on p. 300

Scompaiono i filtri e in scena si combinano eleganza, ordine e raffinatezza. Sipario si compone di moduli armadio senza ante, da accostare in modo libero secondo le proprie esigenze pratiche ed il proprio gusto estetico. Vasta la scelta delle finiture, esaltate, nella versione con telaio, dalla presenza di un'ampia cornice perimetrale che dona alle composizioni un'atmosfera ancora più calda e sofisticata. La gamma di accessori interni è la stessa disponibile per gli armadi ed è in grado di soddisfare ogni esigenza.

^{EN} Curtains dissolve to reveal elegance, order and refinement on stage. Sipario is made up of wardrobe modules without doors that can be unrestrictedly put together to suit individual practical requirements and aesthetic preferences. In the framed version, the vast array of finishes is enhanced by a wide frame that gives the arrangement an even warmer and more sophisticated appeal. To satisfy any requirement, our range of interior accessories is the same available for our wardrobes.

In questo ambiente: **Sipario** cabina con telaio laccato opaco Lavagna ed interno materico Canaletto. **Plana** armadio battente laccato opaco Lavagna, con apertura push pull. **Chloè Vanity** in tessuto Moritz 52 e laccato opaco Lavagna, **Haik** tavolino Argento, **Eden** pouf in tessuto Positano 51, **Abaco** tavolino laccato opaco Melograno.

^{EN} *In this setting:* **Sipario** walk-in closet with frame in Lavagna matt lacquer and interior in Canaletto materico. **Plana** hinged door wardrobe in Lavagna matt lacquered, with push pull opening. **Chloè** dressing table in Moritz 52 fabric and Lavagna matt lacquer, **Haik** side table in Argento, **Eden** ottoman in Positano 51 fabric, **Abaco** side table in Melograno matt lacquer.





Raster con scatole in pelle sintetica Elephant, portascarpe laccato opaco Lavagna, frontale cassetto in vetro laccato lucido Lavagna.

^{EN} Cubbies with boxes in Elephant synthetic leather, shoe shelf in Lavagna matt lacquer, drawer front in Lavagna glossy lacquered glass.

In questo ambiente: **Vista** sistema di chiusura con binario a soffitto e ante Borgogna, maniglia Oro. **Sipario** cabina in materico Borgogna. **Delano** pouf in tessuto Velvet 44, **Servogiro** tavolino con piano laccato lucido Lavagna e struttura Oro.

^{EN} *In this setting:* **Vista** door system with ceiling mounted rail, Borgogna doors and Oro handle. **Sipario** walk-in closet in Borgogna materico. **Delano** ottoman in Velvet 44 fabric, **Servogiro** side table with top in Lavagna high gloss lacquer and Oro structure.







Ripiano in vetro Fumé con telaio materico Borgogna. Frontale cassetto con oblò in vetro Fumé, girocassetto materico Argento e fondo cassetto in pelle sintetica Elephant.

^{EN} Shelf in Fumé glass with frame in Borgogna materico. Drawer front in Fumé glass, Argento materico drawer structure and drawer bottom in Elephant synthetic leather.



Sipario cabina in materico Borgogna e schiena materico Gioia di Carrara opaco, telaio portapantaloni estraibile, ripiani in vetro con telaio Borgogna. **Delano** pouf in tessuto Velvet 44, **Servogiro** tavolino con piano laccato lucido Lavagna e struttura Oro.

^{EN} **Sipario** walk-in closet in Borgogna materico and back panel in matt Gioia di Carrara materico, extractible trouser hanger, glass shelves with Borgogna frame. **Delano** ottoman in Velvet 44 fabric, **Servogiro** side table with top in Lavagna high gloss lacquer and Oro structure.

In questo ambiente: **Sipario** cabina con telaio laccato opaco Argilla, interno materico Borgogna. Attrezzata con ripiani, portascarpe, cassettiere e portapantaloni con vaschetta.

EN In this setting: **Sipario** walk-in closet with Argilla matt lacquered frame, Borgogna materico interior. Equipped with shelves, shoe shelves, drawer units, trouser hangers with tray.





In questo ambiente: **Sipario** cabina in materico Perlage Terra, attrezzata con ripiani in vetro, luce led verticale, portascarpe, cassettiere con frontale vetro laccato lucido Seta. **Anteprima** con schienali in pelle sintetica Elephant, ripiani laccato Ninfea e ripiani con luci led. **Island** modulo doppio con cassetti e ripiani laccato opaco Piombo e teca in vetro trasparente.

EN In this setting: **Sipario** walk-in closet in Perlage Terra materico, equipped with glass shelves, vertical LED lights, shoe shelves, drawer units with front in Seta glossy lacquered glass. **Anteprima** with back panels in Elephant synthetic leather, shelves lacquered in Ninfea and shelves with LED light. **Island** double module with drawers and shelves in Piombo matt lacquer and transparent glass top.









Island laccato opaco Piombo, vassoi con griglia Manganese e accessori interni in pelle sintetica Elephant, teca in vetro trasparente. Cassetto con telaio estraibile Manganese e ripiano in vetro Fumé.

^{EN} **Island** in Piombo matt lacquer, trays with grid in Manganese and internal accessories in Elephant synthetic leather, transparent glass top. Drawer with Manganese extractible frame and shelf in Fumé glass.

Info tecniche
EN Technical info

Struttura

EN Structure

Componenti

EN Components

Massima flessibilità per costruire uno spazio domestico riservato e personale grazie alla varietà di componenti che assicura una massima libertà progettuale, in grado di inserirsi in ogni spazio,

EN Maximum flexibility to build a personal and private space in your home, thanks to the number of modules granting a complete freedom of design, capable of fitting in every space

Basi e Cappelli

EN Bases and Tops

Le basi sono dotate di piedini regolabili, EN The bases are equipped with adjustable feet

Finiture, EN Finishes

Laccato Opaco, EN Matt Lacquered

Materico: Bianco, Borgogna, Canaletto, Rovere Laguna, Perlage Terra, Perlage Conchiglia

Tutti i componenti laccati e vetro sono personalizzabili con i colori RAL, EN All lacquered and glass componets can be lacquered in the colors of the RAL range

Fianchi, sp 3 cm

EN Sides, 1.18" th

Presentano nella parte interna un'impronta ogni 6.4 cm per il posizionamento dei ripiani spostabili,

EN On the inside there are marks for shelf support every 2.52"

Finiture esterne, EN External Finishes

Laccato Opaco o Lucido, Alaska laccato, EN Matt or High Gloss Lacquered, Alaska Lacquered

Soft Touch

Essenza, EN Wood: Borgogna, Canaletto, Rovere Fumo, Rovere Grigio, Rovere Laguna, Rovere Naturale, Rovere Tabacco

Materico: Bianco, Cenere, Seta, Alaska, Corsica

Finiture interne, EN Internal Finishes

Materico: Bianco, Borgogna, Canaletto, Rovere Laguna, Perlage Terra, Perlage Conchiglia

Laccato Opaco, EN Matt Lacquered

Fianchi di finitura

EN Finishing Sides

Finiture esterne, EN External Finishes

Laccato Opaco o Lucido, EN Matt or High Gloss Lacquered

Soft Touch

Essenza, EN Wood: Borgogna, Canaletto, Rovere Fumo, Rovere Grigio, Rovere Laguna, Rovere Naturale, Rovere Tabacco

Vetro, EN Glass: Laccato Opaco o Lucido, EN Matt or Glossy Lacquered

Metallizzato Bronzo

Specchio, EN Mirror: Argento, Fumè, Piombo

Finiture interne, EN Internal Finishes

Materico: Bianco, Borgogna, Canaletto, Rovere Laguna, Perlage Terra, Perlage Conchiglia

Laccato Opaco, EN Matt Lacquered

Divisori

EN Partitions

Per battente e scorrevole sp 2.2 cm, per complanare sp 4.5 cm. Per cabina soffietto sp 2.2 e 5 cm. Presentano nella parte interna un'impronta ogni 6.4 cm per il posizionamento dei ripiani spostabili,

EN For hinged and sliding doors 0.86"th, for flush sliding door 1.77" th Folding door dressing closets 0.86"and 1.97"th on both sides there are marks for shelf support every 2.52"

Finiture, EN Finishes

Materico: Bianco, Borgogna, Canaletto, Rovere Laguna, Perlage Terra, Perlage Conchiglia

Laccato Opaco, EN Matt Lacquered

Schienali

EN Backs

Finiture

Materico: Bianco, Borgogna, Canaletto, Rovere Laguna, Perlage Terra, Perlage Conchiglia

Materico Marmo opaco o lucido, EN Marble materico Matt or Glossy: Gioia di Carrara, Emperador, Grafite

Laccato Opaco, EN Matt Lacquered

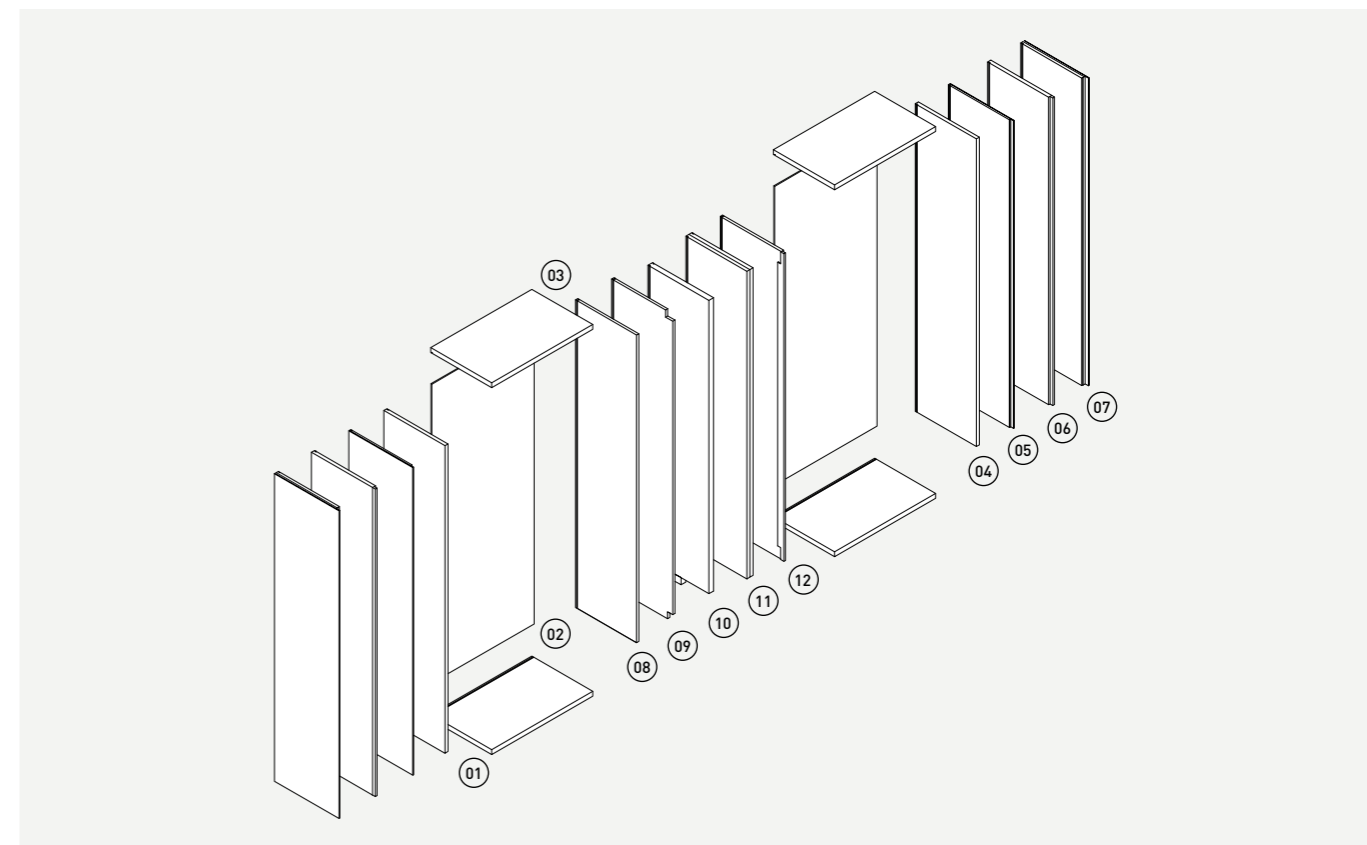

Nomenclatura

EN Nomenclature

01
Base sp 4 cm,
EN Base 1.57" th

02
Schienale sp 0.8 cm,
EN Back panel 0.31" th

03
Cappello sp 4 cm,
EN Top 1.57" th

04
Fianco legno sp 3 cm,
EN Wooden side 1.18" th

05
Fianco di finitura
battente sp 1.9 cm,
EN Finishing side for
hinged door 0.75" th

06
Fianco legno cornice
per battente sp 3 cm,
EN Wooden side frame
for hinged door 1.18" th

07
Fianco di finitura per
scorrevole o complanare
sp 3.9 cm,
EN Finishing side for sliding
or flush sliding door 1.54" th

Divisori interni
EN Internal partitions
08
Battente sp 2.2 cm,
EN Hinged door 0.87" th

09
Scorrevole sp 2.2 cm,
EN Sliding door 0.87" th

10
Complanare sp 4.5 cm,
EN Flush sliding door
1.77" th

11
Scorrevole 4 ante sp 3+3 cm,
EN 4 Sliding door wardrobe
1.30"+ 1.30"th

12
Con cornice per unione
battente e scorrevole sp
2.2 cm,
EN With frame for
connection with hinged
and sliding door modules
0.87" th

Finiture interne

^{EN} Internal finishes



Materico Bianco



Laccato Opaco nei colori della collezione
^{EN} Matt Lacquered in all the colors of our collection



Perlage Conchiglia



Perlage Terra

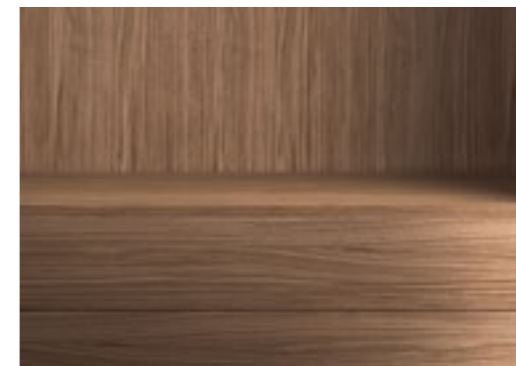

Materico Canaletto



Materico Borgogna

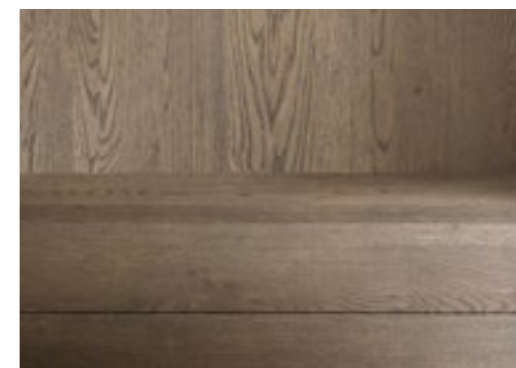

Materico Rovere Laguna

Tutte le finiture interne sono applicabili a: Base, Cappello, Ripiani, Interno Fianchi, Schienali e Divisori. ^{EN} All internal finishes are available for: Base, Top, Shelves, Internal Sides, Backs and Partitions.

Tipologia aperture

EN Opening types

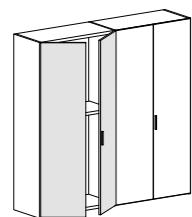

Battente

EN Hinged door

Le ante battenti con maniglia sono dotate di cerniere a molla a chiusura automatica con effetto decelerante. Su richiesta sono disponibili cerniere con apertura a 155°.

EN Hinged doors with handle are equipped with soft-closing hinges. Upon request it is possible to use 155° hinges

Modelli, EN Models

Cornice, Manhattan, Milano, Nastro, Raggio, Tratto, Vitrum, Icona, Plana

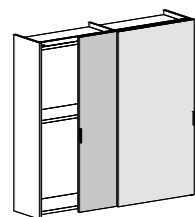

Scorrevole

EN Sliding door

Le ante scorrevoli sono dotate di sistema Soft in apertura e chiusura con effetto decelerante.

EN Sliding doors are equipped with a Soft opening and closing device

Modelli, EN Models

Cornice, Crea, Manhattan, Nastro, Raggio, Tratto, Vela, Vitrum, Icona, Plana

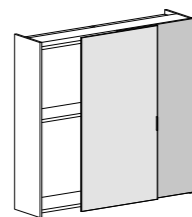

Complanare

EN Flush sliding door

Le ante complanari sono dotate di sistema Soft in apertura e chiusura con effetto decelerante.

EN Flush sliding doors are equipped with a Soft opening and closing device

Modelli, EN Models

Plana, Nastro, Raggio, Crea, Vela, Cornice, Icona

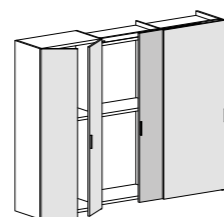

Aperture Miste

EN Mixed openings

Ante scorrevoli e battenti possono essere affiancate tra di loro.

EN Hinged and sliding doors can be used in combination

Modelli, EN Models

Cornice, Crea, Manhattan, Milano, Nastro, Raggio, Tratto, Vela, Vitrum, Icona, Plana

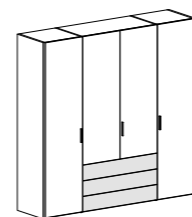

Cassetti

EN Drawers

Cassetti ad estrazione ammortizzata da abbinare ad ante battenti.

EN Drawers with soft closing that can be used with hinged doors

Modelli, EN Models

Nastro, Plana

Modularità

EN Modularity

Battente

EN Hinged door

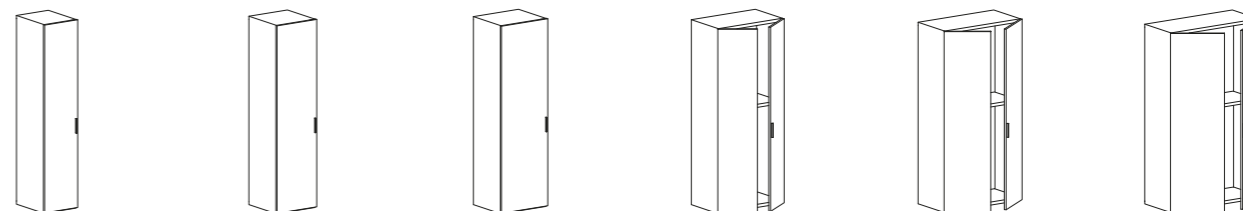

L 47.8 P 42.3 - 59 cm W 18.81" D 16.65" - 23.23"
 L 57.8 P 42.3 - 59 cm W 22.76" D 16.65" - 23.23"
 L 67.8 P 42.3 - 59 cm W 26.69" D 16.65" - 23.23"
 L 97.8 P 42.3 - 59 cm W 38.50" D 16.65" - 23.23"
 L 117.8 P 42.3 - 59 cm W 46.38" D 16.65" - 23.23"
 L 137.8 P 42.3 - 59 cm W 54.25" D 16.65" - 23.23"

Scorrevole

EN Sliding door

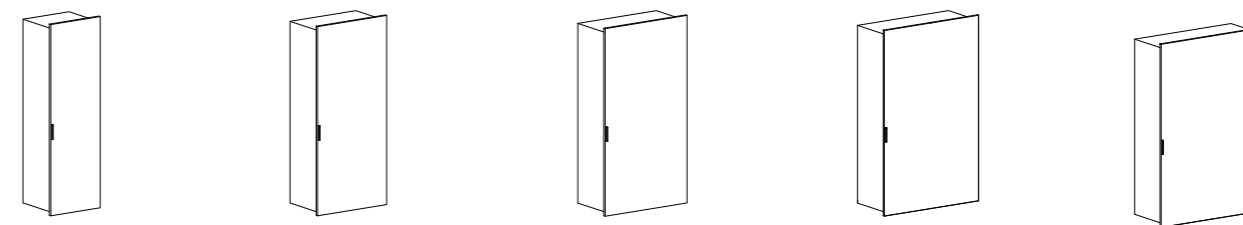

L 67.8 P 42.3 - 59 cm W 26.69" D 16.65" - 23.23"
 L 97.8 P 42.3 - 59 cm W 38.50" D 16.65" - 23.23"
 L 117.8 P 42.3 - 59 cm W 46.38" D 16.65" - 23.23"
 L 137.8 P 42.3 - 59 cm W 54.25" D 16.65" - 23.23"
 L 147.8 P 42.3 - 59 cm W 58.19" D 16.65" - 23.23"

Complanare

EN Flush Sliding door

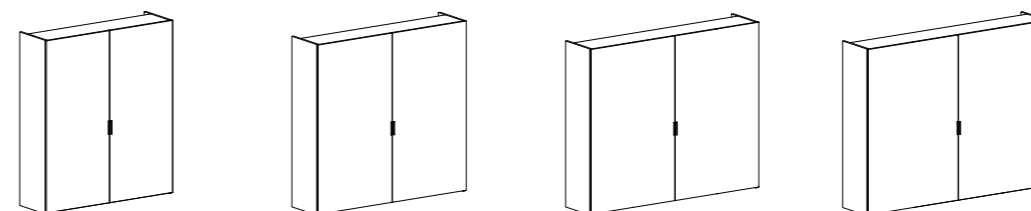

L 206 P 59 cm W 81.10" D 23.23"
 L 246 P 59 cm W 96.85" D 23.23"
 L 286 P 59 cm W 112.60" D 23.23"
 L 306 P 59 cm W 120.47" D 23.23"

Modularità

EN Modularity



Cornice **Crea** **Icona** **Manhattan** **Milano** **Nastro**

B S C B S C B S C B S C B S C B S C

Modulo, ^{EN} Module

L 47.8 cm W 18.81"	•					
L 57.8 cm W 22.76"	•					
L 67.8 cm W 26.69"	•	•				
L 97.8 cm W 38.50"	•	•	•			
L 117.8 cm W 46.38"	•	•	•			
L 137.8 cm W 54.25"	•	•	•			
L 147.8 cm W 58.19"		•	•			
Terminale, ^{EN} Terminal	•					

Altezza, ^{EN} Height

H 238.5 cm W 93.90"	•	•	•			
H 257.7 cm W 101.46"	•	•	•			
H 289.7 cm W 114.06"						
Su Misura, ^{EN} Custom size	•	•	•			

Angolo, ^{EN} Corner

Battente, ^{EN} Hinged door	•					
Angolo opposto, ^{EN} External corner						
Scorrevole, ^{EN} Sliding door						

Cabina, ^{EN} Dressing closet

Angolare a soffietto, ^{EN} Folding door corner	•					
Terminale a soffietto, ^{EN} Folding door terminal	•					

Legenda
B Battente, ^{EN} Hinged door
S Scorrevole, ^{EN} Sliding door
C Complanare, ^{EN} Flush sliding door



Plana **Raggio** **Tratto** **Vela** **Vitrum**

B S C B S C B S C B S C B S C

Modulo, ^{EN} Module

L 47.8 cm W 18.81"	•					
L 57.8 cm W 22.76"	•					
L 67.8 cm W 26.69"	•	•				
L 97.8 cm W 38.50"	•	•	•			
L 117.8 cm W 46.38"	•	•	•			
L 137.8 cm W 54.25"	•	•	•			
L 147.8 cm W 58.19"		•	•			
Terminale, ^{EN} Terminal	•					

Altezza, ^{EN} Height

H 238.5 cm W 93.90"	•	•	•			
H 257.7 cm W 101.46"	•	•	•			
H 289.7 cm W 114.06"	•	•				
Su Misura, ^{EN} Custom size	•	•	•			

Angolo, ^{EN} Corner

Battente, ^{EN} Hinged door	•					
Angolo opposto, ^{EN} External corner	•					
Scorrevole, ^{EN} Sliding door						

Cabina, ^{EN} Dressing closet

Angolare a soffietto, ^{EN} Folding door corner	•					
Terminale a soffietto, ^{EN} Folding door terminal	•					

Legenda
 * Non disponibile per la versione vetro,
^{EN} Not available in the glass version

Moduli speciali

EN Special modules

- 01**
Terminale,
EN Terminal module
- 02**
Pannelli per modulo
centrostanza,
EN Panels for all-side
finished module
- 03**
Cabina angolare con
apertura soffietto,
EN Corner dressing closet
with folding doors
- 04**
Modulo TV,
EN TV module
- 05**
Angolo battente opposto,
EN External corner module
- 06**
Modulo con vano a giorno,
EN Module with open
compartment
- 07**
Angolo battente,
EN Hinged door corner
module
- 08**
Cassettiera esterna,
EN External drawer unit
- 09**
Modulo a ponte con
scrivania, EN Bridge
module with desk
- 10**
Terminale a scrigno,
EN Module with L-shaped
opening
- 11**
Modulo per
elettrodomestici,
EN Module for household
appliances
- 12**
Modulo stagionale,
EN Seasonal module
- 13**
Angolo scorrevole,
EN Sliding door corner
module
- 14**
Modulo sovrapporta,
EN Over door module
- 15**
Terminale attrezzato,
EN Equipped terminal
module

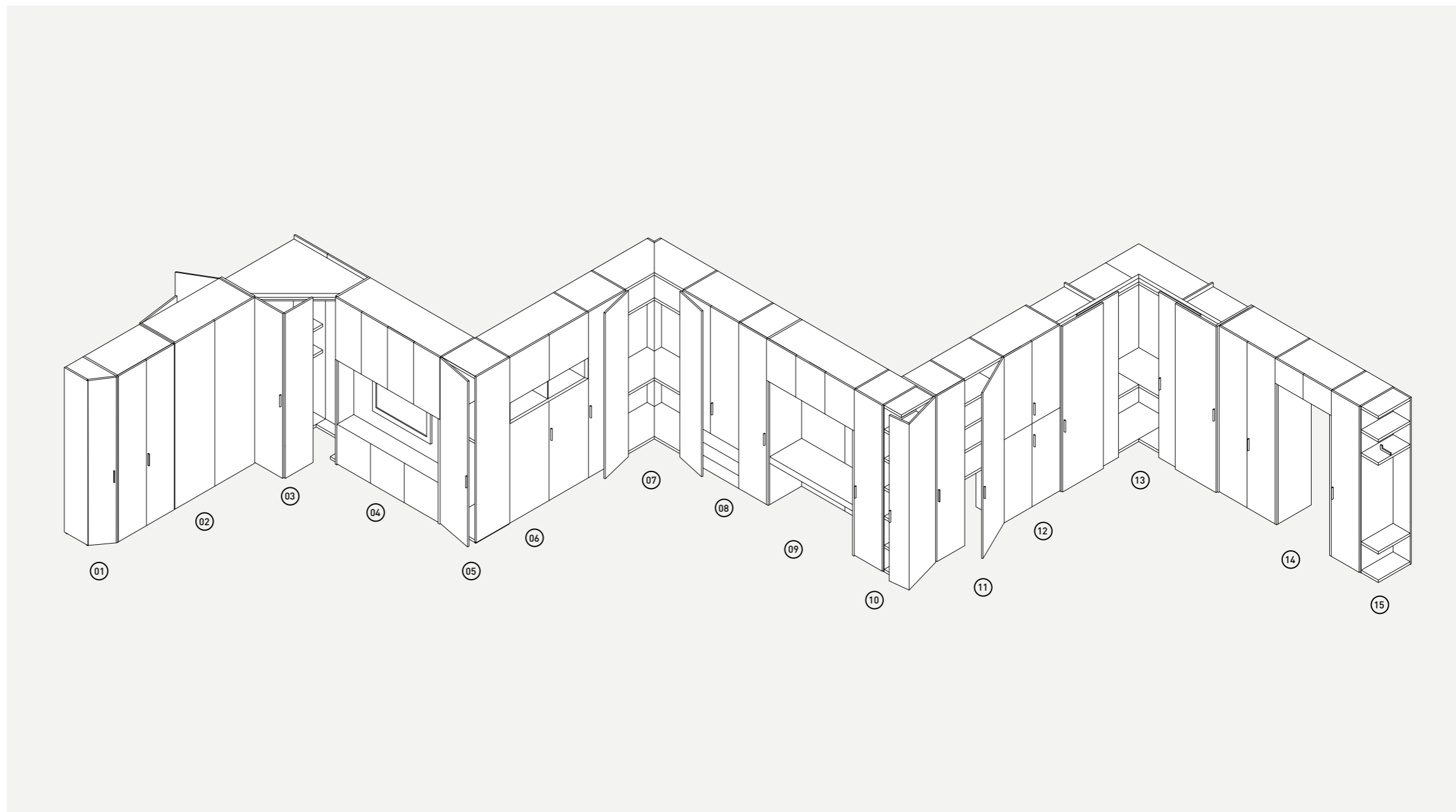

**Collezione ante
EN Doors collection**

Cornice

Aperture EN Openings

Battente, Scorrevole,
Complanare,
EN Hinged, Sliding, Flush
sliding doors

Finiture EN Finishes

Laccato Opaco o Lucido,
Alaska Laccato, EN Matt
or High Gloss Lacquered,
Alaska Lacquered

+RAL, Soft touch

Essenza, EN Wood:
Borgogna, Canaletto,
Rovere Fumo, Rovere
Grigio, Rovere Laguna
Rovere Naturale, Rovere
Tabacco

Materico: Bianco, Cenere,
Seta, Alaska, Corsica

Vetro, EN Glass:
Laccato Opaco o Lucido,
EN Matt or Glossy
Lacquered

+RAL, Metallizzato
Bronzo

Specchio, EN Mirror:
Argento, Fumé, Piombo

Pelle Sintetica,
EN Synthetic Leather:
Creta, Elephant, Talpa



Maniglia e telaio EN Handle and frame

H 110 cm - 43.31"

Alluminio Anodizzato Nero,
EN Black Anodized
Alluminum

Laccato Opaco,
EN Matt Lacquered

Battente EN Hinged door

P 42.3 - 59 cm
H 238.5 - 257.7 cm
su misura

D 16.65" - 23.23"
H 93.90" - 101.46"
custom size

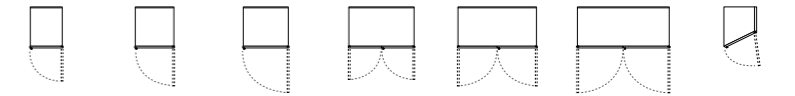

L 47.8 cm W 18.81" L 57.8 cm W 22.76" L 67.8 cm W 26.69" L 97.8 cm W 38.50" L 117.8 cm W 46.38" L 137.8 cm W 54.25" L 46.1 cm* W 18.15"*

*No profondità 42.3 cm, EN Not available depth 16.65"

Scorrevole EN Sliding door

P 42.3 - 59 cm
H 238.5 - 257.7 cm
su misura

D 16.65" - 23.23"
H 93.90" - 101.46"
custom size



L 67.8 cm W 26.69" L 97.8 cm W 38.50" L 117.8 cm W 46.38" L 137.8 cm* W 54.25"* L 147.8 cm* W 58.19"*

*Larghezza divisa in 2 pannelli, EN Door divided in 2 panels

Complanare EN Flush Sliding door

P 59 cm
H 238.5 - 257.7 cm
su misura

D 23.23"
H 93.90" - 101.46"
custom size



L 206 cm W 81.10" L 246 cm W 96.85" L 286 cm* W 112.60"* L 306 cm* W 120.47"*

*Larghezza divisa in 2 pannelli, EN Door divided in 2 panels

Soluzioni Angolari EN Corner Solutions

Dimensioni pag. 255 - 259
P 42.3 - 59 cm
H 238.5 - 257.7 cm
su misura

EN Dimensions on pag.
255 - 259
D 16.65" - 23.23"
H 93.90" - 101.46"
custom size



Battente
EN Hinged
doors

Cabina
EN Folding
door corner

Cabina terminale
EN Folding door
terminal

01 *No profondità 42.3 cm, EN Not available depth 16.65"

Aperture EN Openings

Scorrevole, Complanare,
EN Sliding, Flush sliding
doors

Finiture EN Finishes

Vetro, EN Glass:
Laccato Opaco o Lucido,
EN Matt or Glossy
Lacquered

+RAL

Maniglie EN Handles

Laccato Opaco,
EN Matt Lacquered

Essenza, EN Wood:
Borgogna, Canaletto,
Rovere Fumo, Rovere
Grigio, Rovere Laguna
Rovere Naturale, Rovere
Tabacco



Scorrevole EN Sliding door

P 42.3 - 59 cm
H 238.5 - 257.7 cm

D 16.65" - 23.23"
H 93.90" - 101.46"



L 97.8 cm
W 38.50"



L 117.8 cm
W 46.38"



L 137.8 cm
W 54.25"



L 147.8 cm
W 58.19"

Complanare EN Flush Sliding door

P 59 cm
H 238.5 - 257.7 cm

D 23.23"
H 93.90" - 101.46"

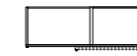

L 206 cm
W 81.10"



L 246 cm
W 96.85"



L 286 cm
W 112.60"



L 306 cm
W 120.47"

Nella stessa anta non
si possono abbinare
differenti colori di vetri.
Le ante di tipo A e tipo
B non possono essere
modificate esteticamente
nè rese speculari,
EN It is not possible to
combine different glass
colors in the same door.
Type A and type B doors
cannot be reversed or
modified.

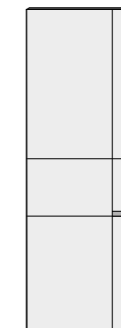

Tipo A

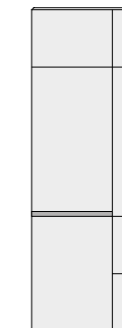

Tipo B

Aperture EN Openings

Battente, Scorrevole,
Complanare,
EN Hinged, Sliding, Flush
sliding doors

Finiture EN Finishes

Laccato Opaco o Lucido,
Alaska Laccato, EN Matt or
High Gloss Lacquered,
Alaska Lacquered

+RAL, Soft touch

Essenza, EN Wood:
Borgogna, Canaletto,
Rovere Fumo, Rovere
Grigio, Rovere Laguna
Rovere Naturale, Rovere
Tabacco

Materico: Bianco, Genere,
Seta, Alaska, Corsica

Maniglia EN Handle

Laccato Opaco, EN Matt
Lacquered

+RAL

Finiture Metallo,
EN Metal Finishes:
Bronzo, Cromo, Oro,
Rame, Titanio

L 20.2 H 5.2 cm
Orizzontale;
L 7 H 40 cm
Verticale

W 7.95" H 2.05"
Orizzontale;
W 2.75" H 15.75"
Vertical



Battente EN Hinged door

P 42.3 - 59 cm
H 238.5 - 257.7 - 289.7 cm
su misura

D 16.65" - 23.23"
H 93.90" - 101.46" - 114.06"
custom size

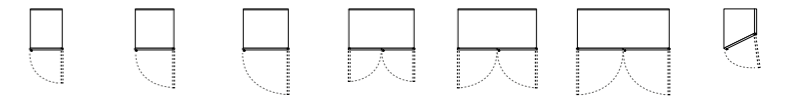

L 47.8 cm W 18.81" L 57.8 cm W 22.76" L 67.8 cm W 26.69" L 97.8 cm W 38.50" L 117.8 cm W 46.38" L 137.8 cm W 54.25" L 46.1 cm* W 18.15"*

*No profondità 42.3 cm, EN Not available depth 16.65"

Scorrevole EN Sliding door

P 42.3 - 59 cm
H 238.5 - 257.7 - 289.7 cm
su misura

D 16.65" - 23.23"
H 93.90" - 101.46" - 114.06"
custom size



L 67.8 cm W 26.69" L 97.8 cm W 38.50" L 117.8 cm W 46.38" L 137.8 cm* W 54.25"* L 147.8 cm* W 58.19"*

*No altezza 289.7 cm, EN Not available height 114.06"

*Larghezza divisa in 2 pannelli, EN Door divided in 2 panels

Complanare EN Flush Sliding door

P 59 cm
H 238.5 - 257.7 - 289.7 cm
su misura

D 23.23"
H 93.90" - 101.46" - 114.06"
custom size



L 206 cm W 81.10" L 246 cm W 96.85" L 286 cm* W 112.60"* L 306 cm* W 120.47"*

*Larghezza divisa in 2 pannelli, EN Door divided in 2 panels

Soluzioni Angolari EN Corner Solutions

Dimensioni pag. 255 - 259
H 238.5 - 257.7 - 289.7 cm
su misura

EN Dimensions on page
255 - 259
H 93.90" - 101.46" - 114.06"
custom size

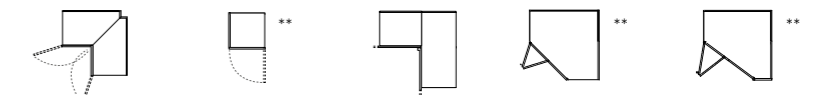

Battente EN Hinged doors Opposto EN External opening Scorrevole* EN Sliding doors* Cabina* EN Folding door corner* Cabina terminale* EN Folding door terminal*

*No altezza 289.7 cm, EN Not available height 114.06"

**No profondità 42.3 cm, EN Not available depth 16.65"

Manhattan

Aperture EN Openings

Battente, Scorrevole,
EN Hinged, Sliding door

Finiture EN Finishes

Laccato Opaco o Lucido,
EN Matt or High Gloss
Lacquered

+RAL, Soft Touch

Essenza, EN Wood:
Borgogna, Canaletto,
Rovere Fumo, Rovere
Grigio, Rovere Laguna
Rovere Naturale, Rovere
Tabacco

Vetro*, EN Glass*:
Laccato Opaco o Lucido,
EN Matt or Glossy
Lacquered,

+RAL, Metallizzato
Bronzo

Specchio*, EN Mirror*:
Argento, Fumé, Piombo

*Disponibile solo per anta
battente, EN Available only
for hinged doors



Maniglie EN Handles

Laccato Opaco o Lucido,
EN Matt or High Gloss
Lacquered

Soft Touch

Essenza, EN Wood:
Borgogna, Canaletto,
Rovere Fumo, Rovere
Grigio, Rovere Laguna
Rovere Naturale, Rovere
Tabacco

Finiture Metallo,
EN Metal Finishes:
Bronzo, Oro, Rame,
Titanio, Cromo

Battente EN Hinged door

P 42.3 - 59 cm
H 238.5 - 257.7 cm
su misura

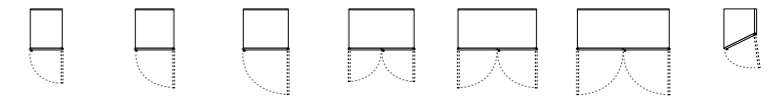

L 47.8 cm W 18.81" L 57.8 cm W 22.76" L 67.8 cm W 26.69" L 97.8 cm W 38.50" L 117.8 cm W 46.38" L 137.8 cm W 54.25" L 46.1 cm* W 18.15"*

*No profondità 42.3 cm, EN Not available depth 16.65"

Scorrevole EN Sliding door

P 42.3 - 59 cm
H 238.5 - 257.7 cm
su misura



L 67.8 cm* W 26.69"* L 97.8 cm* W 38.50"* L 117.8 cm* W 46.38"*

*Non disponibile per anta vetro, EN Not available for glass door

Soluzioni Angolari EN Corner Solutions

Dimensioni pag. 255 - 259
P 42.3 - 59 cm
H 238.5 - 257.7 cm
su misura

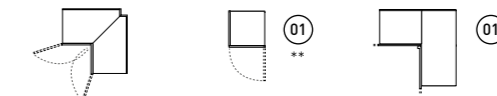

EN Dimensions on page
255 - 259
D 16.65" - 23.23"
custom size

Battente
EN Hinged
doors

Opposto
EN External
opening

Scorrevole
EN Sliding
doors

01 Non disponibile per anta vetro, EN Not available for glass door
**No profondità 42.3 cm, EN Not available depth 16.65"

Milano

Aperture EN Opening

Battente, EN Hinged door

Finiture EN Finishes

Vetro, EN Glass:
Extrachiaro Trasparente,
Fumé Trasparente, Fumé
Satinato, Metallizzato
Bronzo, Stop sol, Trama
Argento, Trama Bronzo,
Trama Fumé

Specchio, EN Mirror:
Argento, Fumé, Piombo

Maniglia e telaio EN Handle and frame

Canna di Fucile, Silicio,
EN Gunmetal grey,
Metallized brown



Battente EN Hinged door

P 42.3 - 59 cm
H 238.5 - 257.7 - 289.7 cm
su misura

D 16.65" - 23.23"
H 93.90" - 101.46" - 114.06"
custom size



L 47.8 cm
W 18.81"



L 57.8 cm
W 22.76"



L 67.8 cm
W 26.69"



L 97.8 cm
W 38.50"



L 117.8 cm
W 46.38"



L 137.8 cm
W 54.25"

Soluzioni Angolari EN Corner Solutions

Dimensioni pag. 255 - 259
P 42.3 - 59 cm
H 238.5 - 257.7 - 289.7 cm
su misura

EN Dimensions on page
255 - 259
D 16.65" - 23.23"
H 93.90" - 101.46" - 114.06"
custom size

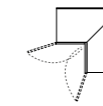

Battente
EN Hinged
doors

Nastro

Aperture EN Openings

Battente, Scorrevole,
Complanare
EN Hinged, Sliding, Flush
sliding doors

Finiture EN Finishes

Laccato Opaco o Lucido,
Alaska Laccato, EN Matt or
High Gloss Lacquered,
Alaska Lacquered

+RAL, Soft touch

Essenza, EN Wood:
Borgogna, Canaletto,
Rovere Fumo, Rovere
Grigio, Rovere Laguna
Rovere Naturale, Rovere
Tabacco

Materico: Bianco, Cenere,
Seta, Alaska, Corsica

Vetro, EN Glass:
Laccato Opaco o Lucido,
EN Matt or Glossy
Lacquered

+RAL, Metallizzato Bronzo

Specchio, EN Mirror:
Argento, Fumé, Piombo

Maniglia EN Handle

Laccato Opaco,
EN Matt Lacquered

Finiture Metallo,
EN Metal Finishes:
Bronzo, Oro, Rame,
Titanio, Cromo



Battente EN Hinged door

No altezza 289.7 cm per anta vetro, EN Not available height 114.06" for glass door

P 42.3 - 59 cm
H 238.5 - 257.7 - 289.7 cm
su misura

D 16.65" - 23.23"
H 93.90" - 101.46" - 114.06"
custom size

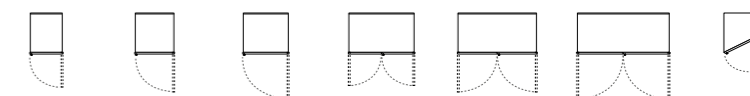

L 47.8 cm W 18.81" L 57.8 cm W 22.76" L 67.8 cm W 26.69" L 97.8 cm W 38.50" L 117.8 cm W 46.38" L 137.8 cm W 54.25" L 46.1 cm* W 18.15"*

*No profondità 42.3 cm, EN Not available depth 16.65"

Scorrevole EN Sliding door

No altezza 289.7 cm per anta vetro, EN Not available height 114.06" for glass door

P 42.3 - 59 cm
H 238.5 - 257.7 - 289.7 cm
su misura

D 16.65" - 23.23"
H 93.90" - 101.46" - 114.06"
custom size



L 67.8 cm W 26.69" L 97.8 cm W 38.50" L 117.8 cm W 46.38" L 137.8 cm* W 54.25"* L 147.8 cm* W 58.19"*

*No altezza 289.7 cm per anta legno, EN Not available height 114.06" for wooden door
*Larghezza divisa in 2 pannelli, EN Door divided in 2 panels

Complanare EN Flush Sliding door

P 59 cm
H 238.5 - 257.7 cm
su misura

D 23.23"
H 93.90" - 101.46"
custom size



L 206 cm W 81.10" L 246 cm W 96.85" L 286 cm* W 112.60"* L 306 cm* W 120.47"*

*Larghezza divisa in 2 pannelli, EN Door divided in 2 panels

Soluzioni Angolari EN Corner Solutions

Dimensioni pag. 255 - 259
P 42.3 - 59 cm
H 238.5 - 257.7 - 289.7 cm
su misura

EN Dimensions on page
255 - 259
D 16.65" - 23.23"
H 93.90" - 101.46" - 114.06"
custom size

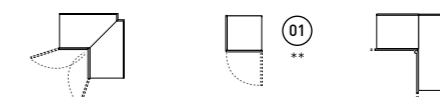

Battente*
EN Hinged
doors*

Opposto
EN External
opening

Scorrevole*
EN Sliding
doors*

*No altezza 289.7 cm per anta vetro, EN Not available height 114.06" for glass door
**No profondità 42.3 cm, EN Not available depth 16.65"

01 Non disponibile per anta vetro, EN Not available for glass door

Raggio

Aperture EN Openings

Battente, Scorrevole,
Complanare
EN Hinged, Sliding, Flush
sliding doors

Finiture EN Finishes

Vetro, EN Glass:
Laccato Opaco o Lucido,
EN Matt or Glossy
Lacquered

+RAL

Specchio, EN Mirror:
Argento, Fumé, Piombo

Maniglia EN Handle

Laccato Opaco,
EN Matt Lacquered

Finiture Metallo,
EN Metal Finishes:
Bronzo, Oro, Rame,
Titanio, Cromo



Battente EN Hinged door

P 42.3 - 59 cm
H 238.5 - 257.7 cm
su misura

D 16.65" - 23.23"
H 93.90" - 101.46"
custom size

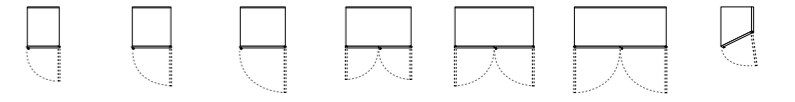

L 47.8 cm W 18.81" L 57.8 cm W 22.76" L 67.8 cm W 26.69" L 97.8 cm W 38.50" L 117.8 cm W 46.38" L 137.8 cm W 54.25" L 46.1 cm* W 18.15"*

*No profondità 42.3 cm, EN Not available depth 16.65"

Scorrevole EN Sliding door

P 42.3 - 59 cm
H 238.5 - 257.7 cm
su misura

D 16.65" - 23.23"
H 93.90" - 101.46"
custom size



L 67.8 cm W 26.69" L 97.8 cm W 38.50" L 117.8 cm W 46.38" L 137.8 cm* W 54.25"* L 147.8 cm* W 58.19"*

*Larghezza divisa in 2 pannelli, EN Door divided in 2 panels

Complanare EN Flush Sliding door

P 59 cm
H 238.5 - 257.7 cm
su misura

D 23.23"
H 93.90" - 101.46"
custom size



L 206 cm W 81.10" L 246 cm W 96.85" L 286 cm* W 112.60"* L 306 cm* W 120.47"*

*Larghezza divisa in 2 pannelli, EN Door divided in 2 panels

Soluzioni Angolari EN Corner Solutions

Dimensioni pag. 255 - 259
P 42.3 - 59 cm
H 238.5 - 257.7 cm
su misura

EN Dimensions on page
255 - 259
D 16.65" - 23.23"
H 93.90" - 101.46"
custom size

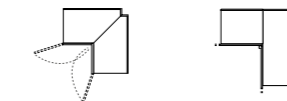

Battente
EN Hinged
doors

Scorrevole
EN Sliding
doors

Tratto

Aperture EN Openings

Battente, Scorrevole,
EN Hinged, Sliding doors

Finiture EN Finishes

Laccato Opaco o Lucido,
EN Matt or High Gloss
Lacquered

+RAL, Soft Touch

Essenza, EN Wood:
Borgogna, Canaletto,
Rovere Fumo, Rovere
Grigio, Rovere Laguna
Rovere Naturale, Rovere
Tabacco

Maniglia EN Handle

Verticale ricavata
nell'anta, EN Vertical
groove



Battente EN Hinged door

P 42.3 - 59 cm
H 238.5 - 257.7 cm
su misura

D 16.65" - 23.23"
H 93.90" - 101.46"
custom size

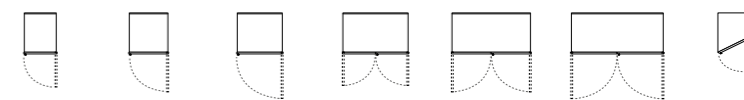

L 47.8 cm L 57.8 cm L 67.8 cm L 97.8 cm L 117.8 cm L 137.8 cm L 46.1 cm*
W 18.81" W 22.76" W 26.69" W 38.50" W 46.38" W 54.25" W 18.15"*

*No profondità 42.3 cm, EN Not available depth 16.65"

Scorrevole EN Sliding door

P 42.3 - 59 cm
H 238.5 - 257.7 cm
su misura

D 16.65" - 23.23"
H 93.90" - 101.46"
custom size



L 97.8 cm L 117.8 cm
W 38.50" W 46.38"

Soluzioni Angolari EN Corner Solutions

Dimensioni pag. 255 - 259
P 42.3 - 59 cm
H 238.5 - 257.7 cm
su misura

EN Dimensions on page
255 - 259
D 16.65" - 23.23"
H 93.90" - 101.46"
custom size

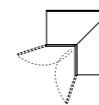

Battente
EN Hinged
doors



Opposto
EN External
opening



Scorrevole
EN Sliding
doors



Cabina
EN Folding door
corner



Cabina terminale
EN Folding door
terminal

**No profondità 42.3 cm, EN Not available depth 16.65"

Vela

Aperture EN Openings

Scorrevole, Complanare
EN Sliding, Flush sliding
doors

Finiture EN Finishes

Pannello inferiore e
superiore, EN Lower and
upper door panel

Laccato Opaco o Lucido,
EN Matt or High Gloss
Lacquered

+RAL, Soft touch

Fascia centrale, EN Central panel

Essenza, EN Wood:
Borgogna, Canaletto,
Rovere Fumo, Rovere
Grigio, Rovere Laguna
Rovere Naturale, Rovere
Tabacco

Laccato Opaco o Lucido,
EN Matt or High Gloss
Lacquered

+RAL

Maniglia EN Handle

Verticale in tinta con
pannello centrale dell'
anta, EN Vertical handle
inserted in the central
panel of the door



Scorrevole EN Sliding doors

P 42.3 - 59 cm
H 238.5 - 257.7 cm

D 16.65" - 23.23"
H 93.90" - 101.46"



L 97.8 cm
W 38.50"



L 117.8 cm
W 46.38"



L 137.8 cm
W 54.25"



L 147.8 cm
W 58.19"

Complanare EN Flush Sliding door

P 59 cm
H 238.5 - 257.7 cm

D 23.23"
H 93.90" - 101.46"

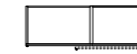

L 206 cm
W 81.10"



L 246 cm
W 96.85"

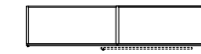

L 286 cm
W 112.60"

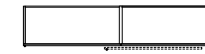

L 306 cm
W 120.47"

Aperture EN Openings

Battente, Scorrevole,
EN Hinged, Sliding doors

Finiture EN Finishes

Vetro, EN Glass:
Fumé Trasparente,
Fumé Satinato, Stop-sol,
Trama Argento, Trama
Bronzo, Trama Fumé,
Trasparente Extrachiaro

Maniglia e telaio EN Handle and frame

H 110 cm - 43.31"

Alluminio Anodizzato
Nero, EN Black Anodized
Alluminum



Battente EN Hinged door

P 42.3 - 59 cm
H 238.5 - 257.7 cm

D 16.65" - 23.23"
H 93.90" - 101.46"

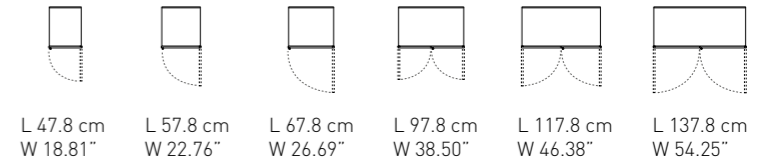

Scorrevole EN Sliding door

P 42.3 - 59 cm
H 238.5 - 257.7 cm

D 16.65" - 23.23"
H 93.90" - 101.46"



Plana

Aperture EN Openings

Battente, Scorrevole,
Complanare,
EN Hinged, Sliding, Flush
sliding doors

Finiture EN Finishes

Laccato Opaco o Lucido,
Alaska Laccato, EN Matt
or High Gloss Lacquered,
Alaska Lacquered

+RAL, Soft touch

Essenza, EN Wood:
Borgogna, Canaletto,
Rovere Fumo, Rovere
Grigio, Rovere Laguna
Rovere Naturale, Rovere
Tabacco

Materico: Bianco, Cenere,
Seta, Alaska, Corsica



Maniglie EN Handles

	B	S	C
A18	•	•	•
A39	•	•	•
A84	•	•	•
B12	•		
D30	•	•	
H5		•	
L110	•	•	•
V30	•	•	
V72	•	•	
Y30	•	•	
Y110	•	•	
W40	•	•	•
W110	•	•	•
Push pull	•		
Chiave	•		
Ser. El./Mec.	•		

Legenda

B Battente, EN Hinged door
S Scorrevole, EN Sliding door
C Complanare, EN Flush
sliding door

Battente EN Hinged door

P 42.3 - 59 cm
H 238.5 - 257.7 - 289.7 cm
su misura

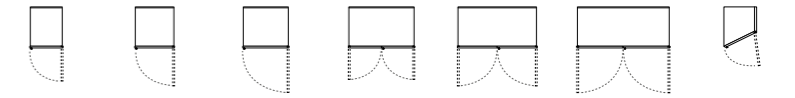

D 16.65" - 23.23"
H 93.90" - 101.46" - 114.06"
custom size

L 47.8 cm W 18.81" L 57.8 cm W 22.76" L 67.8 cm W 26.69" L 97.8 cm W 38.50" L 117.8 cm W 46.38" L 137.8 cm W 54.25" L 46.1 cm* W 18.15"*

*No profondità 42.3 cm, EN Not available depth 16.65"

Scorrevole EN Sliding door

P 42.3 - 59 cm
H 238.5 - 257.7 - 289.7 cm
su misura



D 16.65" - 23.23"
H 93.90" - 101.46" - 114.06"
custom size

L 67.8 cm W 26.69" L 97.8 cm W 38.50" L 117.8 cm W 46.38" L 137.8 cm* W 54.25"* L 147.8 cm* W 58.19"*

*No altezza 289.7 cm, EN Not available height 114.06"
*Larghezza divisa in 2 pannelli, EN Door divided in 2 panels

Complanare EN Flush Sliding door

P 59 cm
H 238.5 - 257.7 cm
su misura

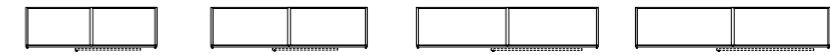

D 23.23"
H 93.90" - 101.46"
custom size

L 206 cm W 81.10" L 246 cm W 96.85" L 286 cm* W 112.60"* L 306 cm* W 120.47"*

*Larghezza divisa in 2 pannelli, EN Door divided in 2 panels

Soluzioni Angolari EN Corner Solutions

Dimensioni pag. 255 - 259
P 42.3 - 59 cm
H 238.5 - 257.7 - 289.7 cm
su misura



EN Dimensions on page
255 - 259
D 16.65" - 23.23"
H 93.90" - 101.46" - 114.06"
custom size

Battente
EN Hinged
doors Opposto
EN External
opening Scorrevole*
EN Sliding
doors* Cabina*
EN Folding door
corner* Cabina terminale*
EN Folding door
terminal*

*No altezza 289.7 cm, EN Not available height 114.06"
**No profondità 42.3 cm, EN Not available depth 16.65"

Maniglie

EN Handles

Finiture EN Finishes

Essenza, ^{EN} Wood:
Borgogna, Canaletto,
Rovere Fumo, Rovere
Grigio, Rovere Laguna
Rovere Naturale, Rovere
Tabacco

Laccato Opaco,
^{EN} Matt Lacquered

Finiture Metallo,
^{EN} Metal Finishes:
Bronzo, Cromo, Oro,
Rame, Titanio

Alluminio Anodizzato
Nero, ^{EN} Black Anodized
Alluminum

Cuoio, ^{EN} Leather:
Moro, Nero, Siena



A 18

Laccato, ^{EN} Lacquered
Finiture Metallo,
^{EN} Metal Finishes
Essenza, ^{EN} Wood



V 30

Cromo satinato,
Alluminio



A 39

Laccato, ^{EN} Lacquered
Finiture Metallo,
^{EN} Metal Finishes
Essenza, ^{EN} Wood



V 72

Cromo satinato,
Alluminio



A 84

Laccato, ^{EN} Lacquered
Finiture Metallo,
^{EN} Metal Finishes
Essenza, ^{EN} Wood



D 30

Laccato ^{EN} Lacquered
Finiture Metallo,
^{EN} Metal Finishes



L 110

Laccato, ^{EN} Lacquered
Finiture Metallo,
^{EN} Metal Finishes
Alluminio



B 12

Cuoio, ^{EN} Leather



W 40

Laccato, ^{EN} Lacquered
Essenza, ^{EN} Wood



H 5

Finiture Metallo,
^{EN} Metal Finishes,
Cromo, Brunito



W 110

Laccato, ^{EN} Lacquered
Essenza, ^{EN} Wood



Chiave

Cuoio, ^{EN} Leather:
Moro



Y 30

Laccato, ^{EN} Lacquered
Finiture metallo,
^{EN} Metal Finishes



Push pull



Y 110

Laccato, ^{EN} Lacquered
Finiture metallo,
^{EN} Metal Finishes

Moduli speciali
^{EN} Special modules

Modulo stagionale

EN Seasonal module

Modularità

EN Modularity

P 42.3 - 59 cm
L 47.8 - 57.8 - 67.8 - 97.8
117.8 - 137.8 cm
H 238.5 - 257.7 - 289.7 cm
su misura

D 16.65" - 23.23"
W 18.81" - 22.76" - 26.69"
38.50" - 46.38" - 54.25"
H 93.90" - 101.46" - 114.06"
custom size

Altezza minima dell'anta
64 cm. Previste altezze
intermedie a passo 6.4 cm,
EN Minimum door height:
25.20". Other heights
available at a 2.52" pitch.

Modelli

EN Models

Plana battente, EN Hinged
door:

Esclusi moduli angolo e
terminali,
EN Except for corner and
terminal modules

Finiture Interne

EN Internal Finishes

Materico: Bianco,
Borgogna, Canaletto,
Rovere Laguna, Perlage
Conchiglia, PerlageTerra

Laccato Opaco,
EN Matt Lacquered

Maniglie

EN Handles

A18, A39, D30, W40, V30

Possono essere
posizionate a 2.6 cm dal
filo superiore o inferiore
dell'anta; o mantenere la
posizione della maniglia
di serie,

EN Can be positioned
at 1.02" from the door's
upper or lower edge;
or kept in its standard
position



Modulo per elettrodomestici

EN Module for household appliances

Modularità

EN Modularity

P 59 cm
L 67.8 cm
H 238.5 - 257.7 - 289.7 cm
su misura

D 23.23"
W 26.69"
H 93.90" - 101.46" - 114.06"
custom size

Ripiano con profondità
maggiorata sul retro e
a filo struttura davanti,
posizionato sempre da
terra a 100 cm

Elettrodomestici
L max 60 cm
H max 90 cm,

EN Shelf with increased
depth at the back and
flush with the front
structure, always
positioned at a height
of 39.37"

Household appliances
W max 23.62"
H max 35.43"

Modelli

EN Models

Plana battente, EN Hinged
door

Finiture Interne

EN Internal Finishes

Materico: Bianco,
Borgogna, Canaletto,
Rovere Laguna, Perlage
Conchiglia, PerlageTerra

Laccato Opaco,
EN Matt Lacquered

Maniglie

EN Handles

A18, A39, A 84, B12, D30,
L110, V30, V72, W40, W110,
Y30, Y110, Push-pull

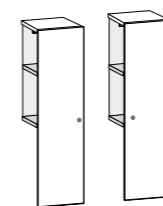

Modulo cassetiera esterna

EN External drawer units module

Modularità EN Modularity	Modelli EN Models	Finiture Interne EN Internal Finishes	Maniglie EN Handles
P 42.3 - 59 cm L 47.8 - 57.8 - 67.8 - 97.8 117.8 - 137.8 cm H 238.5 - 257.7 - 289.7 cm su misura	Nastro*, Plana *Solo per anta legno, EN Only for wooden doors	Materico: Bianco, Borgogna, Canaletto, Rovere Laguna, Perlage Conchiglia, PerlageTerra Laccato Opaco, EN Matt Lacquered	Plana: A18, B12, D30, Y30, Push pull Cassetti, EN Drawer units: Y30, Push pull Nastro: maniglia di serie, EN Standard handle

01-02 Plana Anta, EN Door

Cassetto H 19.7 cm,
EN Drawer H 7.76"

2 Cassetti, EN Drawers
3 Cassetti, EN Drawers
4 Cassetti, EN Drawers

Cestone H 29.7 cm,
EN Tall drawer H 11.69"

1 Cassetto, EN Drawer
2 Cassetti, EN Drawers

03-04 Nastro Anta, EN Door

Cassetto H 19.7 cm,
EN Drawer H 7.76"

2 Cassetti, EN Drawers
4 Cassetti, EN Drawers

Cestone H 29.7 cm
EN Tall drawer H 11.69"

2 Cassetti, EN Drawers



01



02



03



04

Modulo con vano a giorno

EN Module with open element

Modularità EN Modularity	Modelli EN Models	Finiture Interne EN Internal Finishes	Finiture modulo giorno, EN Open element finishes	Maniglie EN Handles
P 42.3 - 59 cm L 47.8 - 57.8 - 67.8 - 97.8 117.8 - 137.8 cm H 238.5 - 257.7 - 289.7 cm su misura	Plana	Materico: Bianco, Borgogna, Canaletto, Rovere Laguna, Perlage Conchiglia, PerlageTerra Laccato Opaco, EN Matt Lacquered	Laccato Opaco, EN Matt Lacquered, +RAL. Essenza, EN Wood: Borgogna, Canaletto, Rovere Fumo, Rovere Grigio, Rovere Laguna Rovere Naturale, Rovere Tabacco Schiena disponibile anche nella finitura specchio e materico marmo, EN Back panels available also in mirror finish or marble materico	Moduli superiori push pull. Modulo inferiore tutte le maniglie anta Plana, EN Push pull for upper modules. All Plana handles for lower modules

Modulo giorno, EN Open elements

P 35 - 45 cm
H 34.4 cm

D 13.78" - 17.72"
H 13.54"

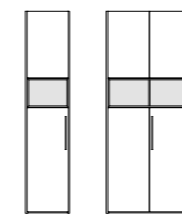

A Posizione, EN Position

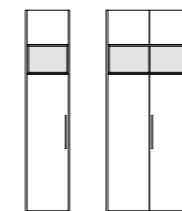

B Posizione, EN Position

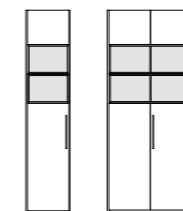

C Posizione, EN Position

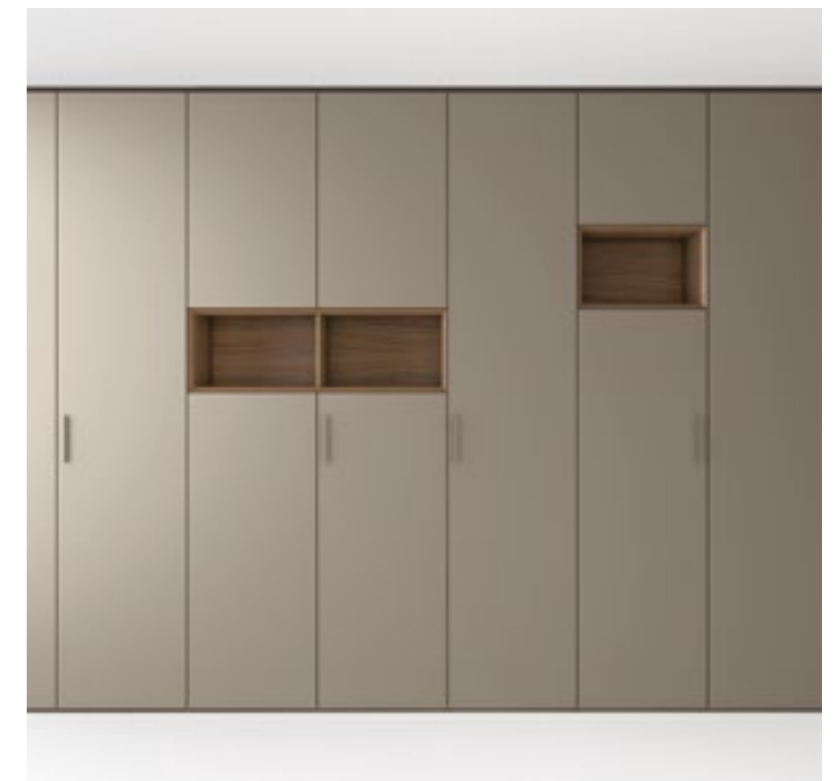

Modulo sovrapporta

EN Over door module

Modularità

EN Modularity

P 42.3 - 59 cm
L 104 - 124 cm
H 238.5 - 257.7 - 289.7 cm
su misura

D 16.65" - 23.23"
W 40.94" - 48.82"
H 93.90" - 101.46" - 114.06"
custom size

Altezza modulo,

EN Height of module

H 38.4 - 64 cm
H 15.12" - 25.20"

Altezza passaggio,

EN Under-module height

H 200.4 - 219.6 - 226 cm
H 78.90" - 86.46" - 88.98"

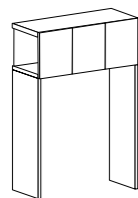
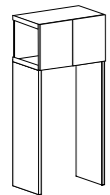

Modelli

EN Models

Nastro*, Raggio, Plana

*Solo per anta vetro,
EN Only for glass door

Finiture Interne

EN Internal Finishes

Materico: Bianco,
Borgogna, Canaletto,
Rovere Laguna, Perlage
Conchiglia, PerlageTerra

Laccato Opaco,
EN Matt Lacquered

Maniglie

EN Handles

Prensilità inferiore,
EN Lower opening



Modulo a ponte

EN Bridge module

Modularità

EN Modularity

P 42.3 - 59 cm
L 104 - 124 - 144 - 154 -
164 - 184 - 204 - 224 cm
H 238.5 - 257.7 cm

D 16.65" - 23.23"
W 40.94" - 48.81" - 56.69"
- 60.63" - 64.57" - 72.44" -
80.31" - 88.19"
H 93.90" - 101.46"

Altezza modulo,

EN Module height

H 64 - 96 cm
H 25.20" - 37.80"

Altezza sottoponte,

EN Under bridge element

H 142.8 - 162 - 174.8 -
194 cm
H 56.22" - 63.78" - 68.82"
- 76.37"

Schienale sottoponte,

EN Under bridge back panel

L 103.6 - 123.6 - 143.6 -
153.6 - 163.6 - 183.6 - 203.6
- 223.6 cm

W 40.78" - 48.66" - 56.53"
- 60.47" - 64.41" - 72.28" -
80.16" - 88.03"

* Per dimensioni
consultare il listino,
EN For dimensis please
see pricelist

Modelli

EN Models

Nastro*, Raggio, Plana

*Solo per anta vetro,
EN Only for glass door

Finiture Interne

EN Internal Finishes

Materico: Bianco,
Borgogna, Canaletto,
Rovere Laguna, Perlage
Conchiglia, PerlageTerra

Laccato Opaco,
EN Matt Lacquered

Maniglie

EN Handles

Prensilità inferiore,
EN Lower opening

Attrezzabilità

EN Accessories

Asta appendiabiti*,
EN Hanging rod*

Mensole sottoponte*,
EN Under bridge shelves*

Ala scrittoio, EN Ala desk

P 56.5 H 10 cm
L 100 - 120 - 140 - 150 -
160 - 180 cm

D 22.24" H 3.94"
W 39.37" - 47.24" - 55.12"
- 59.05" - 62.99" - 70.87"



Modulo TV

EN TV module

Modularità

EN Modularity

P 42.3 - 59 cm
L 104 - 124 - 144 - 154 -
164 - 184 - 204 - 224 cm
H 238.5 - 257.7 cm
su misura

D 16.65" - 23.23"
W 40.94" - 48.81" - 56.69"
- 60.63" - 64.57" - 72.44" -
80.31" - 88.19"
H 93.90" - 101.46"
custom size

Pannelli fissi,

EN Fixed panels

L 100 - 120 - 140 - 150 -
160 - 180 - 200 - 220 cm
H 79.6 - 98.8 - 99.6 -
111.6 - 118.8 cm

W 39.37" - 47.24" - 55.12"
- 59.05" - 62.99" - 70.87"
H 31.34" - 38.90" - 39.21"
- 43.94" - 46.77"

Modelli

EN Models

Nastro*, Raggio, Plana

*Solo per anta vetro,
EN Only for glass door

Finiture Interne

EN Internal Finishes

Materico: Bianco,
Borgogna, Canaletto,
Rovere Laguna, Perlage
Conchiglia, PerlageTerra

Laccato Opaco,
EN Matt Lacquered

Maniglie

EN Handles

Prensilità inferiore,
EN Lower opening

Attrezzabilità

EN Accessories

Mensole, EN Shelves

L 30 P 27.5 cm
W 11.81" D 10.83"

Moduli Spazio,

EN Spazio modules

H 40 - 60 cm
H 15.75" - 23.62"



Angolo battente opposto

EN External hinged corner module

Modularità

EN Modularity

P 59 cm
L 61.5 cm
H 238.5 - 257.7 - 289.7 cm
su misura

D 23.23"
W 24.21"
H 93.90" - 101.46" - 114.06"
custom size

Modelli

EN Models

Manhattan*, Nastro*,
Tratto, Icona, Plana

*Solo per anta legno,
EN Only for wooden door

Finiture Interne

EN Internal Finishes

Materico: Bianco,
Borgogna, Canaletto,
Rovere Laguna, Perlage
Conchiglia, PerlageTerra

Laccato Opaco,
EN Matt Lacquered

Maniglie**

EN Handles**

A18, A39, A 84, B12, D30,
L110, V30, V72, W40, W110,
Y30, Y110, Push-pull

** Solo per anta Plana,
EN Only for Plana door



Angolo battente

EN Hinged corner module

Modularità

EN Modularity

L 94 x 94 P 42.3 cm
 L 110.7 x 110.7 P 59 cm
 H 238.5 - 257.7 - 289.7 cm
 su misura

W 37.01" x 37.01" P 16.65"
 W 43.58" x 43.58" P 23.23"
 H 93.90" - 101.46" - 114.06"
 custom size

Modelli

EN Models

Cornice*, Manhattan*,
 Milano, Nastro*, Raggio*,
 Tratto*, Icona, Plana

*No altezza 289.7 cm,
 EN Not available height
 114.06"

Finiture Interne

EN Internal Finishes

Materico: Bianco,
 Borgogna, Canaletto,
 Rovere Laguna, Perlage
 Conchiglia, PerlageTerra

Laccato Opaco,
 EN Matt Lacquered

Maniglie**

EN Handles**

A18, A39, A84, D30, L110,
 V30, V72, W40, W110,
 Push-pull

Serratura meccanica,
 EN Mechanical lock

** Solo per anta Plana,
 EN Only for Plana door

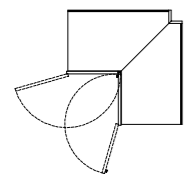

Angolo scorrevole

EN Sliding corner module

Modularità

EN Modularity

L 114 x 114 P 42.3 cm
 L 144 x 144 P 42.3 cm
 L 130.7 x 130.7 P 59 cm
 L 160.7 x 160.7 P 59 cm

H 238.5 - 257.7 cm
 su misura

W 44.88" x 44.88" D 16.65"
 W 56.69" x 56.69" D 16.65"
 W 51.46" x 51.46" D 23.23"
 W 63.27" x 63.27" D 23.23"

H 93.90" - 101.46"
 custom size

Modelli

EN Models

Manhattan*, Nastro,
 Tratto, Icona, Plana

*Solo per anta legno,
 EN Only for wooden door

Finiture Interne

EN Internal Finishes

Materico: Bianco,
 Borgogna, Canaletto,
 Rovere Laguna, Perlage
 Conchiglia, PerlageTerra

Laccato Opaco,
 EN Matt Lacquered

Maniglie**

EN Handles**

A18, A39, A 84, D30, L110,
 V30, V72, W40, W110

** Solo per anta Plana,
 EN Only for Plana door

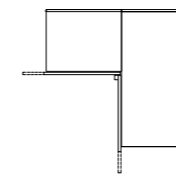

Cabina angolare a soffietto

EN Folding door corner dressing closet

Modularità EN Modularity

P 59 cm
L 131 x 131 cm
H 238.5 - 257.7 cm
su misura

D 23.23"
W 51.57" x 51.57"
H 93.90" - 101.46"
custom size

È possibile accostare ante battenti o scorrevoli Plana, Tratto, Icona, Manhattan, Nastro, Raggio, Crea, Vitrum, Vela,
EN It is possible to combine hinged door modules with sliding door modules for Plana, Tratto, Icona, Manhattan, Nastro, Raggio, Crea, Vitrum, Vela

Modelli EN Models

Cornice, Tratto, Icona, Plana

Finiture Interne EN Internal Finishes

Materico: Bianco, Borgogna, Canaletto, Rovere Laguna, Perlage Conchiglia, PerlageTerra

Laccato Opaco,
EN Matt Lacquered

Maniglie** EN Handles**

A18, A39, A84, V30, V72, D30, B12

** Solo per anta Plana,
EN Only for Plana door

Attrezzabilità EN Accessories

Appendini e vaschetta in alluminio, EN Aluminium hangers and metal tray

Specchio fisso,
EN Fixed mirror
L 36 H 180cm
W 14.17" H 70.87"

Specchio orientabile,
EN Swiveling mirror
L 33 H 140 cm
W 12.99" H 55.12"

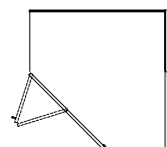

Cabina terminale a soffietto

EN Folding door terminal dressing closet

Modularità EN Modularity

P 59 cm
L 131 x 134 cm
H 238.5 - 257.7 cm
su misura

D 23.23"
W 51.57" x 52.75"
H 93.90" - 101.46"
custom size

È possibile accostare ante battenti o scorrevoli Plana, Tratto, Icona, Manhattan, Nastro, Raggio, Crea, Vitrum, Vela,
EN It is possible to combine hinged door modules with sliding door modules for Plana, Tratto, Icona, Manhattan, Nastro, Raggio, Crea, Vitrum, Vela

Modelli EN Models

Cornice, Tratto, Icona, Plana

Finiture Interne EN Internal Finishes

Materico: Bianco, Borgogna, Canaletto, Rovere Laguna, Perlage Conchiglia, PerlageTerra

Laccato Opaco,
EN Matt Lacquered

Maniglie** EN Handles**

A18, A39, A84, V30, V72, D30, B12

** Solo per anta Plana,
EN Only for Plana door

Attrezzabilità EN Accessories

Appendini e vaschetta in alluminio, EN Aluminium hangers and metal tray

Specchio fisso,
EN Fixed mirror
L 36 H 180cm
W 14.17" H 70.87"

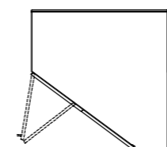

Terminale a giorno

EN Open terminal module

Modularità EN Modularity

P 59 cm
L 30.5 cm
H 238.5 - 257.7 cm

D 23.23"
W 11.81"
H 93.90" - 101.46"

Modelli EN Models

Accostabile a tutti i modelli battente, scorrevole, complanare,
EN It can be combined with all hinged, sliding and flush sliding door modules

Finiture EN Finishes

Materico: Bianco, Borgogna, Canaletto, Rovere Laguna, Perlage Conchiglia, PerlageTerra

Laccato Opaco,
EN Matt Lacquered

Attrezzabilità EN Accessories

Asta appendiabiti,
EN Hanging rods

Ripiani,
EN Shelves



Terminale a scrigno

EN Module with L-shaped opening

Modularità EN Modularity

P 59 cm
L 34.5 cm
H 238.5 - 257.7 cm

D 23.23"
W 13.58"
H 93.90" - 101.46"

Modelli EN Models

Cornice*, Plana**

*Solo per anta legno (no materico) e pelle sintetica,
EN Only for wooden door (not available in materico) and synthetic leather

**No materico,
EN Not available in materico

Finiture Interne EN Internal Finishes

Materico: Bianco, Borgogna, Canaletto, Rovere Laguna, Perlage Conchiglia, PerlageTerra

Laccato Opaco,
EN Matt Lacquered

Maniglie** EN Handles**

A18, A39, A84, B12, D30, L110, W40, W110, Y30, Y110

** Solo per anta Plana,
EN Only for Plana door

Attrezzabilità EN Accessories

Asta appendiabiti,
EN Hanging rods

Ripiani,
EN Shelves

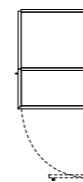

Pannelli per modulo centrostanza

EN Panels for all-side finished modules

Modularità EN Modularity

L da 30 a 122.7 cm
H 238.5 - 257.7 - 289.7 cm

D 23.23"
W from 11.81" to 48.31"
H 93.90" - 101.46" - 114.05"

Modelli EN Models

Battente lineare,
EN Linear hinged door

Scorrevole lineare,
EN Linear sliding door

Solo per modulo sovrapporta,
EN Only for over door module

No moduli angolari,
EN Except for corner modules

Finiture EN Finishes

Laccato Opaco o Lucido,
EN Matt or High Gloss
Lacquered, +RAL, Soft
Touch, Alaska Laccato,
EN Alaska Lacquered

Essenza, EN Wood:
Borgogna, Canaletto,
Rovere Fumo, Rovere
Grigio, Rovere Laguna
Rovere Naturale, Rovere
Tabacco

Materico: Bianco, Cenere,
Seta, Alaska, Corsica

Vetro, EN Glass:
Laccato Opaco o Lucido,
EN Matt or Glossy
Lacquered, +RAL,
Metallizzato Bronzo

Specchio, EN Mirror:
Argento, Fumé, Piombo



Attrezzatura
EN Accessories

Ripiani

EN Shelves

Tipologie

EN Types

01
Ripiano in legno*,
EN Wooden shelf*
Sp 4 cm, Th 1.57"

P 39.5 - 51.1 cm
L 37.8 - 47.8 - 57.8 - 67.8
77.8 - 97.8 - 117.8 - 128.8
137.8 - 147.8 cm

D 15.55" - 20.12"
W 14.88" - 18.81" - 22.76"
26.69" - 30.63" - 38.50"
46.38" - 50.71" - 54.25"
58.19"

Angolo, EN Corner
Terminale, EN Terminal

02
Ripiano in pelle sintetica
con bordo in materico*,
EN Synthetic leather shelf
with materico edge*
Sp 4 cm, Th 1.57"

P 39.5 - 51.1 cm
L 37.8 - 47.8 - 57.8 - 67.8
77.8 - 97.8 - 117.8 - 128.8
137.8 - 147.8 cm

D 15.55" - 20.12"
W 14.88" - 18.81" - 22.76"
26.69" - 30.63" - 38.50"
46.38" - 50.71" - 54.25"
58.19"

03
Ripiano in vetro fumè
EN Fumé glass shelf,
Sp 1.2 cm, Th 0.47"

P 39.5 - 51.1 cm
L 37.8 - 47.8 - 57.8 - 67.8
- 77.8 - 97.8 - 117.8 cm

D 15.55" - 20.12"
W 14.88" - 18.82" - 22.75"
- 26.69" - 30.63" - 38.50"
- 46.38"

04
Ripiano in vetro con telaio
in legno con luce led,
EN Glass shelf with wooden
frame and LED light
Sp 4 cm, Th 1.57"

P 51.1 cm
L 47.8 - 57.8 - 67.8 - 97.8
117.8 cm

D 20.12"
W 18.81" - 22.76" - 26.69"
38.50" - 46.38"

* Disponibile anche
versione a tutta profondità
per moduli P 42.3 - 59 cm,
EN Full-depth version
available for D 16.65" -
23.23"



01



03

Finiture

EN Finishes

Materico: Bianco,
Borgogna, Canaletto,
Rovere Laguna, Perlage
Conchiglia, PerlageTerra

Laccato Opaco,
EN Matt Lacquered

Pelle Sintetica,
EN Synthetic Leather:
Creta, Elephant, Talpa

Vetro, EN Glass:
Fumé



02



04

Divisori interni

EN Internal partitions

Modularità

EN Modularity

Divisori a tutta altezza,
EN Full height partitions

P 39.5 - 51.1 cm
H 238.5 - 257.7 - 289.7 cm

D 15.55" - 20.12"
H 93.90" - 101.46" - 114.05"

**Divisori da base per
moduli battenti, cabina
soffietto, EN Partitions fixed
on the base for hinged
door modules, folding door
dressing closet**

P 39.5 - 51.1 cm
H 46 - 78 - 110 - 142 - 174
206 - 238 cm

D 15.55" - 20.12"
H 18.11" - 30.71" - 43.31" -
55.91" - 68.50" - 81.10" -
93.70

**Divisori da base per
moduli scorrevoli, moduli
complanari, EN Partitions
fixed on the base for
sliding and flush sliding
door modules**

P 39.5 - 51.1 cm
H 41 - 73 - 105 - 137 - 169
201 - 233 cm

D 15.55" - 20.12"
H 16.14" - 28.74" - 41.34"
53.94" - 66.54" - 79.13"
91.73"

Presentano un'impronta
ogni 6.4 cm per il
posizionamento dei
ripiani spostabili,
EN They have a mark every
2.52" for positioning
movable shelves

Finiture

EN Finishes

Materico: Bianco,
Borgogna, Canaletto,
Rovere Laguna, Perlage
Conchiglia, PerlageTerra

Laccato Opaco,
EN Matt Lacquered



Cassettiere

EN Drawer units

Informazioni EN Informations

Sono disponibili elementi interi a uno, due, tre cassetti. Con la sovrapposizione tra loro si possono ottenere multipli a quattro, cinque, sei cassetti. Tutti i cassetti sono dotati di guida invisibile con carrello di scorrimento a rulli, richiamo automatico di chiusura, fermo antigancio e ammortizzatore di chiusura

EN One, two and three-drawer modules are available. Simply by stacking the modules it is possible to create modules with four, five or six drawers. Drawers are equipped with invisible glides with rollers, soft closing a safety locking device.

01
A terra, EN Floor sitting

02
Pensili, EN Suspended

03
Con elementi a T con vano superiore, EN T elements with upper compartment

04
Con elementi a T di pari altezza, EN T elements with the same height

Finiture EN Finishes

Materico: Bianco, Borgogna, Canaletto, Rovere Laguna, Perlage Conchiglia, PerlageTerra

Laccato Opaco, EN Matt Lacquered

Finiture Top EN Top Finishes

Materico: Bianco, Borgogna, Canaletto, Rovere Laguna, Perlage Conchiglia, PerlageTerra

Laccato Opaco, EN Matt Lacquered

Pelle sintetica, EN Synthetic Leather: Creta, Elephant, Talpa

Attrezzabilità EN Accessories

Telaio estraibile, EN Pull-out tray

Serratura elettronica, EN Electronic lock

Accessori pag. 284
EN Accessories pag. 284



01

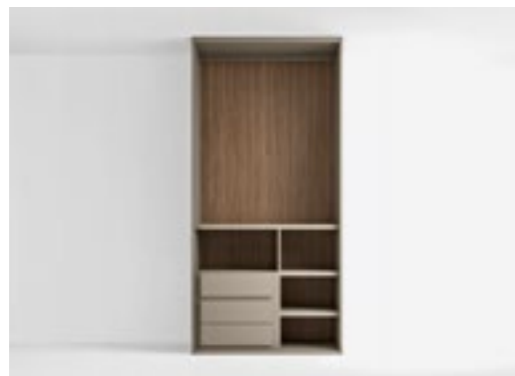

03



02



04

Frontali cassetti

EN Drawer fronts

Modularità EN Modularity

01
Legno, EN Wood
H 9 - 18 - 36 cm
H 3.54" - 7.09" - 14.17"

02
Vetro, EN Glass
H 18 - 36 cm
H 7.09" - 14.17"

03
Con oblò, EN See-through glass front
H 18 cm, H 7.09"

04
Pelle sintetica, EN Synthetic Leather
H 18 - 36 cm
H 7.09" - 14.17"

Finiture EN Finishes

Materico: Bianco, Borgogna, Canaletto, Rovere Laguna, Perlage Conchiglia, PerlageTerra

Laccato Opaco, EN Matt lacquered

Vetro, EN Glass:
Laccato Opaco o Lucido, EN Matt or Glossy
Lacquered

Con oblò, EN See-through glass front:
Extrachiaro Trasparente con cornice Bianco, Fumé con cornice Nero, EN Extrachiaro Trasparente with White frame, Fumé with Black frame

Pelle Sintetica, EN Synthetic Leather:
Creta, Elephant, Talpa

Finiture girocassetto EN Drawer frame finishes

Materico Argento con fondo Piombo, EN Materico Argento with Piombo bottom



01



03



02



04

Cassettiere a terra

EN Floor sitting drawer units

Modularità
EN Modularity

L 57.8 - 67.8 - 97.8 - 117.8
137.8 - 147.8 cm
P 36.1* - 53 cm
H 43 - 64 - 81 - 103 -
120 cm
W 22.76" - 26.69" - 38.50"
46.38" - 54.25" - 58.19"
D 14.21"* - 20.87"
H 16.93" - 25.20" - 31.89"
- 40.55" - 47.24"

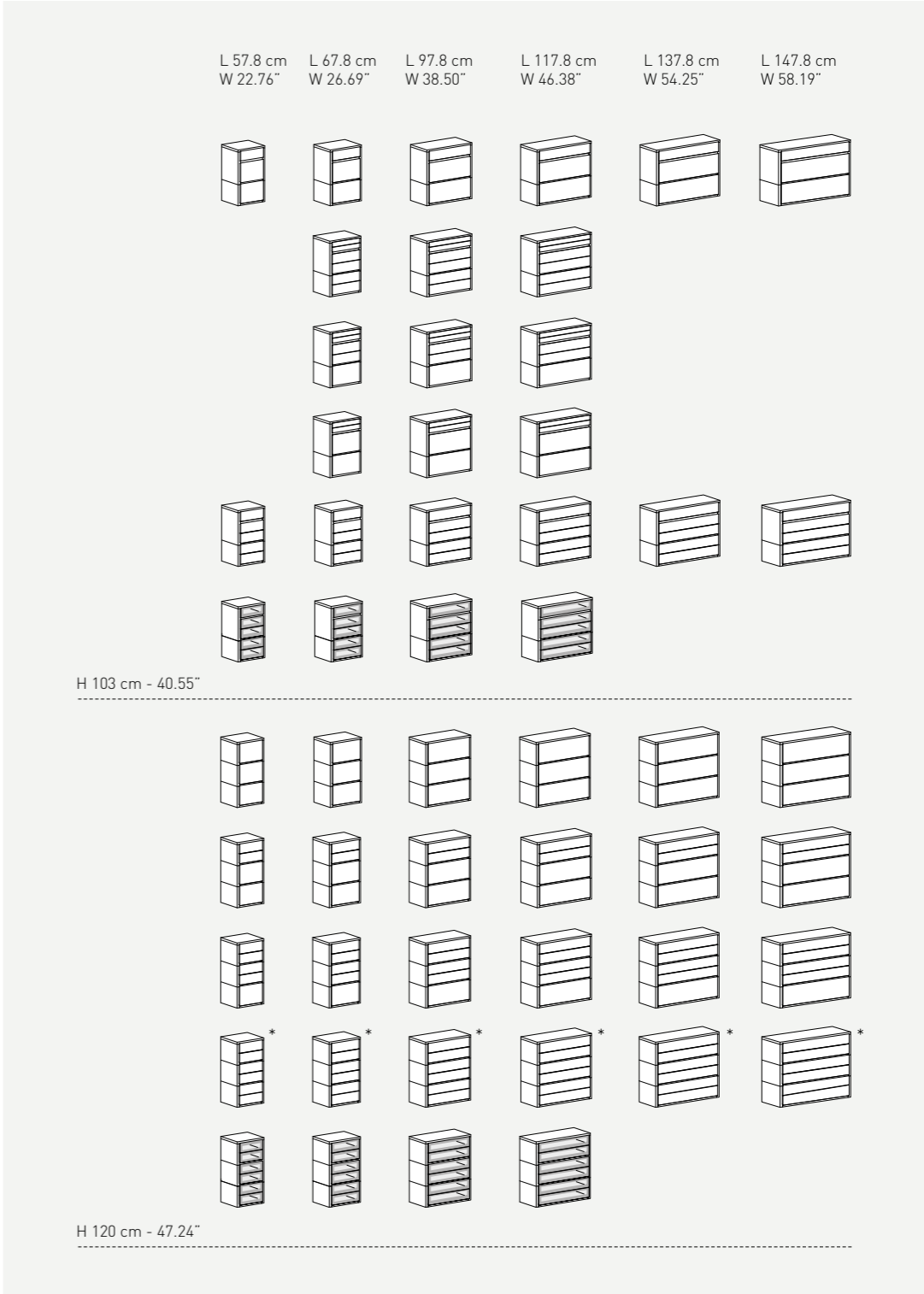
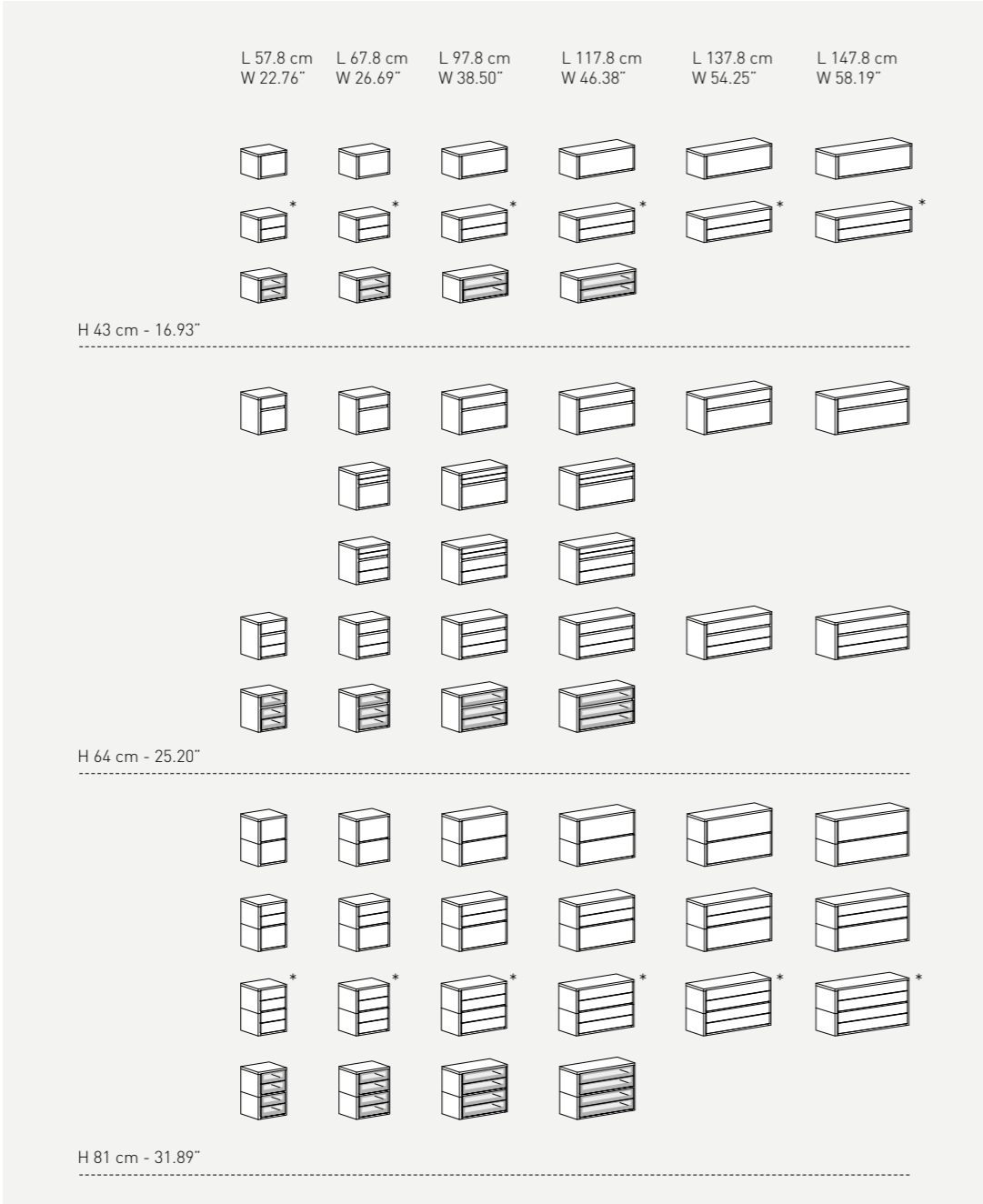

Cassettiere sospese

EN Suspended drawer units

Modularità

EN Modularity

L 57.8 - 67.8 - 97.8 - 117.8
137.8 - 147.8 cm
P 53 cm
H 22 - 38 cm

W 22.76" - 26.69" - 38.50"
46.38" - 54.25" - 58.19"
D 20.87"
H 8.66" - 14.96"

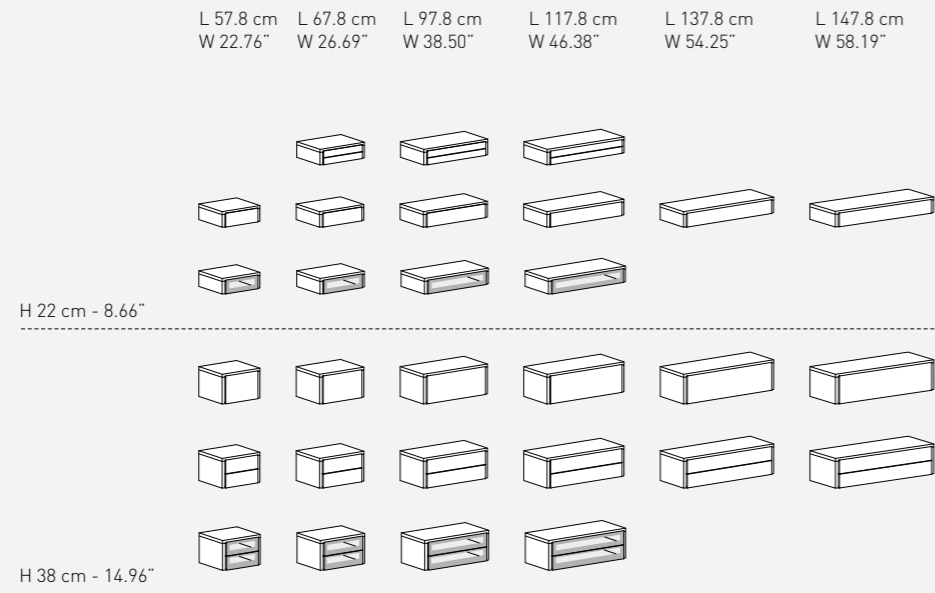

Raster legno

EN Wooden cubbies

Modularità

EN Modularity

L 67.8 - 97.8 - 117.8 cm
P 34.4 - 51.1 cm
H 43 - 62 - 68 - 87 cm

W 26.69" - 38.50" - 46.38"
D 13.54" - 20.12"
H 16.93" - 24.41" - 26.77"
- 34.25"

Contenitori per raster

EN Boxes for cubbies

L 28.2 - 43.2 - 53.2 cm
P 50.5 cm
H 14 cm
W 11.10" - 17.01" - 20.94"
D 19.88"
H 5.51"

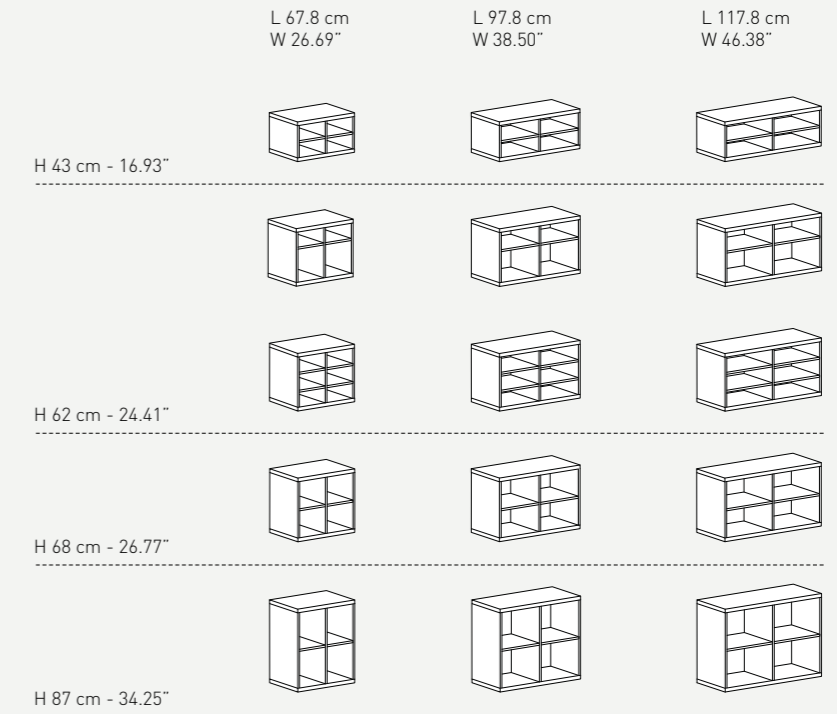

Elemento T per cassettiere

EN T partition for drawer units

Modularità EN Modularity

L 97.8 - 117.8 - 128.8 -
137.8 - 147.8 cm
P 34.4 - 42.3* - 51.1 cm
H 42.4 - 63.7 - 81 - 103 cm

W 38.50" - 46.38" - 50.71"
- 54.25" - 58.19"
D 13.54" - 16.65** - 20.12"
H 16.69" - 25.08" - 31.89"
- 40.55"

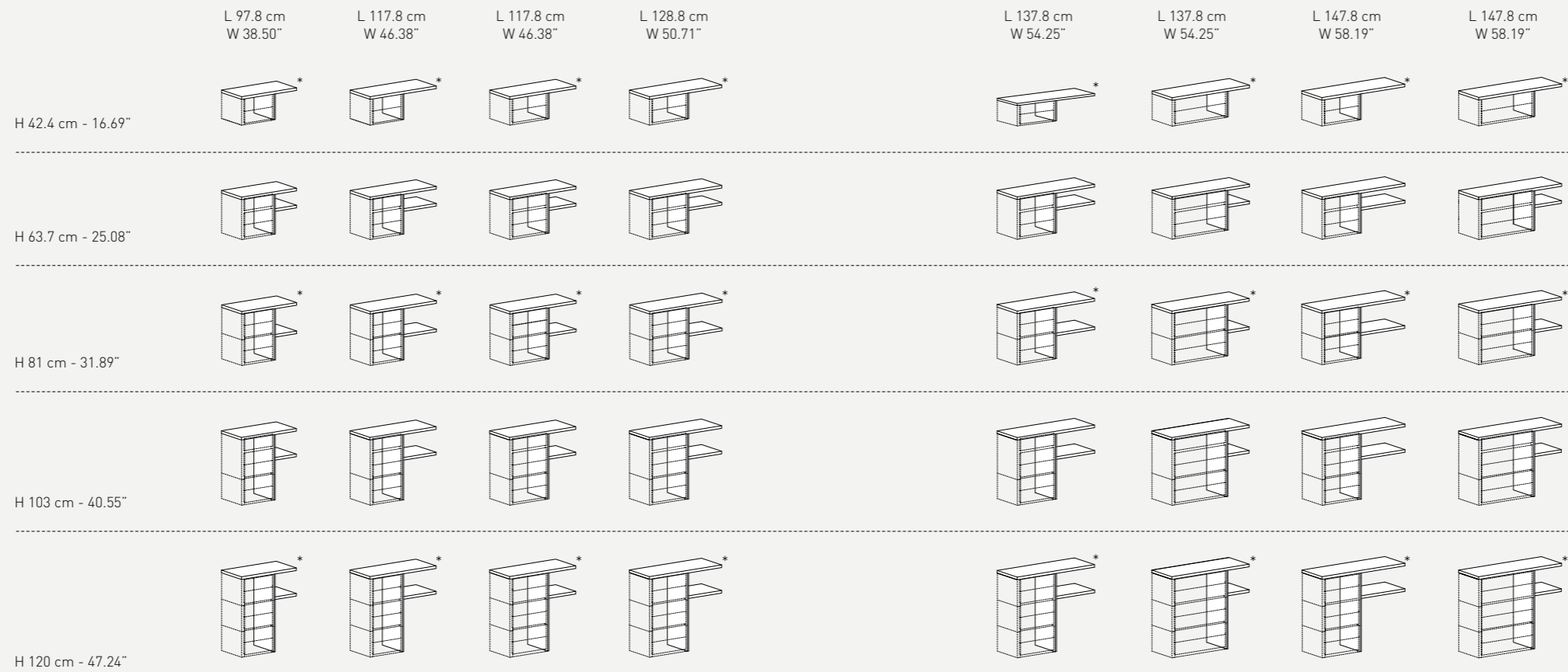

Appenderia

EN Hangers

Tipologie EN Types

01 Servetto estraibile, EN Pull-down rod

L 67.8 - 97.8 - 117.8 cm
W 26.69" - 38.50" - 46.38"

Finitura, EN Finish
Brown

02 Asta appendiabiti, EN Hanging rod

L 37.8 - 47.8 - 57.8 - 67.8
97.8 - 117.8 - 137.8 -
147.8 cm

W 14.88" - 18.81" - 22.76"
26.69" - 38.50" - 46.38"
54.25" - 58.19"

Finitura, EN Finish
Manganese

03 Asta appendiabiti estraibile, EN Pull-out hanging rod

P 36 cm, D 14.17"

Finitura, EN Finish
Cromo

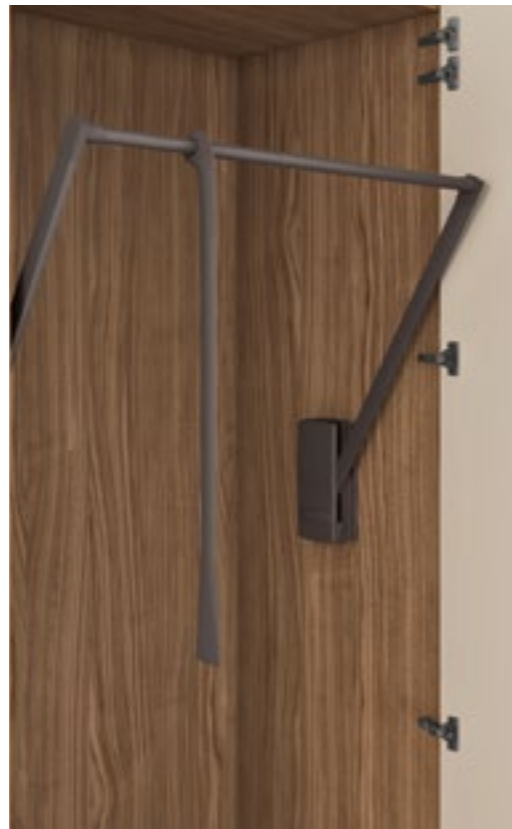

01



02



03

Tipologie EN Types

04 Portacinture, portacravatte da applicare al fianco, divisorio, EN Tie, belt holder for side, partition

P 50 cm D 19.69"

Finitura, EN Finish
Brown

05 Portacravatte, EN Belt holder

L 11 P 36.5 cm
W 4.33" D 14.37"

Finitura, EN Finish
Pelle sintetica,
EN Synthetic leather:
Elephant

06 Pomolo estraibile incassato nel ripiano, EN Pull-out knob recessed inside the shelf

P 10.9 cm ø 2 cm
D 4.29" ø 0.79"

Finitura, EN Finish
Cromo

07 Pomolo estraibile esterno, EN Pull-out knob external

P 17.6 cm ø 2 cm
D 6.93" ø 0.79"

Finitura, EN Finish
Cromo



04



05



06



07

Cassetti attrezzati con telai estraibili

EN Drawers equipped with pull-out frames

Dimensioni EN Dimensions

L 67.8 - 97.8 - 117.8 cm
P 48 cm

W 26.69" - 38.50" - 46.38"
D 18.90"

Finitura telaio,
EN Frame finish
Manganese

Soluzioni per frontali con telai estraibili EN Drawer fronts with pull-out frame

I telai estraibili vengono fissati al frontale del cassetto in sostituzione del girocassetto

EN Pull-out trays are fixed to the drawer front replacing the regular drawer frame

Attrezzabile con: EN Equipped with:

01

Soluzioni cassettiere con telai estraibili in metallo. Frontale H 9 cm,
EN Drawer units with metal pull-out frames. Front H 3.54"

A terra, EN Floor sitting
A - B Vassoio, EN Tray

Pensile, EN Suspended
A Vassoio, EN Tray
B Vassoio, portapantaloni, sacche portabiancheria, EN Tray, trouser rack, hampers

02

Soluzione cassettiere con telai estraibili in metallo Frontale H 18 cm,
EN Drawer units solution with metal pull-out frames Front H 7.09"

A terra, EN Floor sitting
A - B Vassoio, piano in legno o vetro, EN Tray, wooden or glass shelf

Pensile, EN Suspended
A - B Vassoio, piano in legno o vetro, EN Tray, wooden or glass shelf

C Vassoio, piano in legno o vetro, portapantaloni, portagonne, sacche portabiancheria, EN Tray, wooden or glass shelf, trousers rack, skirt rack, hampers

03

Soluzione cassettiere con telai estraibili in metallo e girocassetto legno. Frontale H 36 cm,
EN Drawer units solution with metal pull-out frames and wooden drawer frame. Front H 14.17"

A terra o Pensile, EN Floor sitting or suspended
A - B Vassoio, EN Tray



01 Cassetti chiusi, EN Closed drawers



Cassetti aperti, EN Open drawers



02 Cassetti chiusi, EN Closed drawers



Cassetti aperti, EN Open drawers



03 Cestone chiuso, EN Closed tall drawer



Cestone aperto, EN Open tall drawer

Telai estraibili e accessori

EN Pull-out frames and accessories

Tipologie EN Types

01 Vassoio metallo, EN Metal tray

H 6 cm - 2.36"

Finitura, EN Finish
Manganese

02 Piano vetro Fumé, EN Fumé glass shelf

H 6 cm - 2.36"

03 Piano in legno, EN Wooden shelf

H 6 cm - 2.36"

Finiture, EN Finishes
Materico: Bianco,
Borgogna, Canaletto,
PerlageTerra, Perlage
Conchiglia, Rovere Fumo

Laccato Opaco,
EN Matt lacquered

04 Griglia per vassoio, EN Grid for tray

H 6 cm - 2.36"

Finitura, EN Finish
Manganese

05 Portapantaloni + vaschetta, non disponibile L 67.8 cm, EN Trousers rack + tray, not available W 26.69"

H 6 cm - 2.36"

Soluzioni con telaio EN Pull-out frame solutions

I telai estraibili vengono fissati direttamente alla struttura dell'armadio grazie ai distanziali in legno e sono finiti anteriormente da un frontalino H 5.8 cm in legno

EN The pull-out trays are fixed to the wardrobe structure thanks to wooden spacers and they are equipped with a H 2.30" wooden front

Dimensioni EN Dimensions

L 67.8 - 97.8 - 117.8 cm
P 48 cm

W 26.69" - 38.50" - 46.38"
D 18.90"

Finitura telaio, EN Frame
finish: Manganese

Tipologie EN Types

06 Portapantaloni + portagonne, non disponibile L 67.8 cm, EN Trousers rack + skirt rack, not available W 26.69"

H 6 cm - 2.36"

Finitura, EN Finish
Manganese

07 Portapantaloni, EN Trousers rack

H 6 cm - 2.36"

Finitura, EN Finish
Manganese

08 Portagonne, EN Skirt rack

H 6 cm - 2.36"

Finitura, EN Finish
Manganese

09 Scarpiera in metallo, EN Metal shoe rack

H 15 cm - 5.91"

Finitura, EN Finish
Manganese

10 Sacche portabiancheria in tessuto trapuntato, EN Hampers in tufted fabric

H 31 cm - 12.20"



05



06



01



02



07



08



03



04



09



10

Portascarpe

EN Shoe rack

Tipologie

EN Types

01

Portascarpe fisso,
EN Fixed shoe rack

L da 57.8 a 67.8 cm
P 22 cm

W from 22.76" to 26.69"
D 8.66"

Finitura, EN Finish
Brown



01

02

Portascarpe estraibile
Basic con vaschetta,
EN Basic pull-out shoe
rack with tray

P 50 cm
L 67.8 - 97.8 cm

D 19.69"
W 26.69" - 38.50"

Finitura, EN Finish
Brown



03

03

Ripiano inclinato,
EN Inclined shelf

Sp 4 cm, Th 1.57"

P 39.5 - 51.1 cm
L 37.8 - 47.8 - 57.8 - 67.8 -
77.8 - 97.8 - 117.8 - 137.8
147.8 cm

D 15.55" - 20.12"
W 14.88" - 18.81" - 22.76"
26.69" - 30.63 - 38.50" -
46.38" 54.25" - 58.19"

Cassettiere su ruote

EN Drawer units on castors

Modularità

EN Modularity

Cassettiere autoportanti
con ruote, EN Drawer unit
on castors

L 50 - 70 - 90 - 110 cm
H 44 - 82 cm

W 19.69" - 27.56" - 35.43"
43.31"
H 17.32" - 32.28"



Accessori

EN Accessories

Tipologie

EN Types

01 Appendiera, EN Hangers

Anello grande portasciarpe, foulard e borse, EN Large ring hanger for scarves and bags

Anello piccolo portacravatte o cinture, EN Small ring hanger for ties and belts

Bastone prendi abiti, EN Rod

01a
Gruccia capospalla uomo con portapantaloni, EN Man hanger with trouser hanger

Gruccia portapantaloni, EN Trousers hanger

01b
Gruccia capospalla donna con portagonna, EN Woman hanger with skirt hanger

Gruccia portagonna, EN Skirt hanger

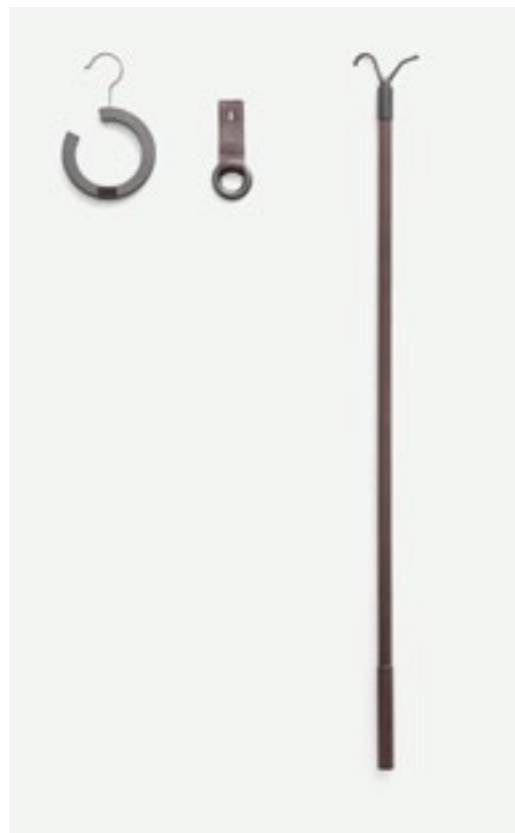

01



01a



01b

Tipologie

EN Types

01 Scatole con coperchio, EN Boxes with lid

L 26 - 40 cm H 40 cm
W 10.24" - 15.75" H 15.75"

02
Vassoio e vassoio con griglia portafoulard, cravatte, cinture, EN Standard tray and basic tray with scarves, ties and belt dividers

L 45.5 P 39 H 6 cm
W 17.91" D 15.35" H 2.36"

03
Svuotatasche: Possono essere inseriti nei cassetti e vassoi, EN Valet trays: they can be inserted in drawers and pull-out trays

P 22.1 L 18.8 H 4 cm
W 8.70" D 7.40" H 1.58"

05 Fondo per cassetti EN Drawer mat

Sipario:
L 67.8 - 97.8 - 117.8 - 137.8 - 147.8 cm
W 26.69" - 38.50" - 46.38" - 54.25" - 58.19"

Anteprima, Island:
L 49.3 - 69.3 - 89.3 - 109.3 cm
W 19.41" - 27.28" - 35.16" - 43.03"

Finiture, EN Finishes
Pelle sintetica, EN Synthetic Leather:
Creta, Elephant



01



02



03



05

A
Porta anelli - orecchini, EN Rings and earrings tray

B
Portagioie, EN Jewellery tray

C
Porta orologio, EN Wrist watch tray

D
Porta bracciali, EN Bracelets tray

Specchi

EN Mirrors

Tipologie

EN Types

01
Specchio estraibile ed orientabile applicabile al fianco scorrevole o complanare, ^{EN} Pull-out and swiveling mirror attached to the side of sliding and flush sliding door wardrobes

L 33 cm H 140 cm
W 12.99" H 55.12"

02
Specchio orientabile applicabile al fianco, ^{EN} Swiveling mirror attached to the side

L 33 cm H 140 cm
W 12.99" H 55.12"

03
Specchio fisso applicabile all'anta battente, ^{EN} Fixed mirror attached to the back of hinged doors

L 36 cm H 180 cm
W 14.17" H 70.87"

04
Specchio fianco di finitura, ^{EN} Mirror side

L 42.3 - 59 cm
W 16.65" - 23.23"

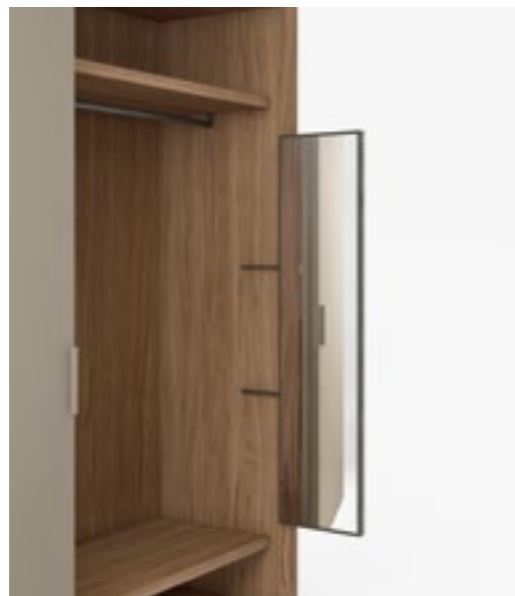

01



02



03



04

Illuminazione

EN Lighting

Tipologie

EN Types

01
Luci led verticali per moduli armadio dotate di sensore di presenza per l'accensione, ^{EN} Vertical LED lights for wardrobe modules with motion sensor

H 238.5 - 257.7 - 289.7 cm
93.90" - 101.46" - 114.06"
Su misura, ^{EN} Custom size

02
Luci led orizzontali per ripiani e cappelli ad incasso dotate di sensore di presenza per l'accensione, ^{EN} Horizontal recessed LED lights for shelves and tops with motion sensor

L 47.8 - 57.8 - 67.8 - 97.8 - 117.8 137.8 - 147.8 cm
W 18.81" - 22.76" - 26.69" - 38.50" - 46.38"

Per ripiano per cabina soffietto, ^{EN} For shelf folding door closet

L 128.8 cm - W 50.71"

Per angolo scorrevole e battente, ^{EN} For sliding and hinged door corner

03
Ripiano con luce, inserita all'interno del telaio e sensore di presenza per l'accensione, ^{EN} Shelf with LED light inserted in the frame with motion sensor

L 47.8 - 57.8 - 67.8 - 97.8 - 117.8 cm
W 18.81" - 22.76" 26.69" - 38.50" - 46.38"



01



02



03

Allestimenti interni

EN Interior configurations



AL

1 Asta appendiabiti,
EN Hanging rods

6 Ripiani legno Sp 4 cm,
EN Wooden shelves 1.57" Th

1 Divisorio interno
H 201 cm, EN Internal
partition H 79.13"

1 Portapantaloni estraibile,
EN Pull-out trouser rack



AD

2 Aste appendiabiti,
EN Hanging rods

1 Ripiano legno Sp 4cm,
EN Wooden shelf 1.57" Th

2 Ripiani legno estraibili,
EN Pull-out wooden shelves

1 Cassettiera a terra
H 81 cm, EN Floor sitting
drawer unit H 31.90"

1 Divisorio interno
H 105 cm, EN Internal
partition H 41.30"



AA

2 Aste appendiabiti,
EN Hanging rods

2 Ripiani legno Sp 4 cm,
EN Wooden shelves 1.57"Th

1 Cassettiera a terra
H 81 cm, EN Floor sitting
drawer unit H 31.89"

1 Divisorio interno
H 174 cm, EN Internal
partition H 68.50"



AN

2 Ripiani legno Sp 4 cm,
EN Wooden shelves 1.57"Th

1 Cassettiera pensile
H 22 cm, EN Suspended
drawer unit H 8.66"

1 cassettiera a terra
H 38 cm, EN Floor sitting
drawer unit H 14.96"



AQ

1 Asta appendiabiti,
EN Hanging rod

1 Ripiani legno Sp 4 cm,
EN Wooden shelves
1.57" Th

1 Cassettiera a terra
H 64 cm, EN Floor-sitting
drawer unit H 25.20"

1 Raster legno H 43 cm,
EN Wooden cubby H 16.93"



AF

2 Aste appendiabiti,
EN Hanging rods

1 Ripiani legno Sp 4 cm,
EN Wooden shelf
1.57" Th

1 Cassettiera a terra
H 64 cm, EN Floor-sitting
drawer unit H 25.20"

1 Raster legno H 43 cm,
EN Wooden cubby H 16.93"

1 Divisorio interno
H 137 cm, EN Internal
partition H 53.94"



AB

1 Asta appendiabiti,
EN Hanging rod

4 Ripiani legno sp 4 cm,
EN Wooden shelves 1.57"Th

3 Ripiani portascarpe,
EN Shoe rack shelves

1 Cassettiera a terra
H 103 cm, EN Floor-sitting
drawer unit H 40.55"

1 Divisorio interno
H 250 cm, EN Internal
partition H 98.43"



AP

1 Asta appendiabiti,
EN Hanging rod

1 Ripiano legno Sp 4 cm,
EN Wooden shelf 1.57"Th

1 cassettiera a terra
H 103 cm, EN Floor sitting
drawer unit H 40.55"

Lavorazioni su misura
EN Made to measure solutions

Riduzioni in altezza

EN Height reduction

Modelli

EN Models

Battente,

EN Hinged door

Cornice, Manhattan, Milano, Nastro, Raggio, Tratto, Icona, Plana

Scorrevole,

EN Sliding door

Cornice, Manhattan, Nastro, Raggio, Tratto, Icona, Plana

Complanare,

EN Flush sliding door

Cornice, Nastro, Raggio, Icona, Plana



Riduzione in larghezza

EN Width reduction

Modelli

EN Models

Battente,

EN Hinged door

Cornice, Manhattan, Milano, Nastro, Tratto, Icona, Plana

Scorrevole,

EN Sliding door

Cornice*, Nastro*, Icona, Plana

Legno, EN Wood:
Cornice, Nastro

*Solo per anta legno,
EN Only for wooden door



Non sono riducibili
aperture complanari,
moduli terminali battenti,
cabine soffietto,
EN It is not possible to
reduce flush sliding door
modules, terminal hinged
door modules, folding
door dressing closets

Riduzioni in profondità

^{EN} Depth reduction

Modelli

^{EN} Models

Battente,

^{EN} Hinged door

Disponibile per tutte le ante battenti,
^{EN} Available for all hinged doors

Scorrevole,

^{EN} Sliding door

Disponibile per tutte le ante scorrevoli,
^{EN} Available for all sliding doors



Non sono riducibili aperture complanari e moduli terminali battenti,
^{EN} It is not possible to reduce flush sliding door modules

Riduzione per pilastri e travi

^{EN} Pillar and beam solutions

Modelli

^{EN} Models

Battente,

^{EN} Hinged door

Disponibile per tutte le ante battenti,
^{EN} Available for all hinged doors

Scorrevole,

^{EN} Sliding door

Disponibile per tutte le ante scorrevoli,
^{EN} Available for all sliding doors



Non sono riducibili aperture complanari e moduli terminali battenti,
^{EN} It is not possible to reduce flush sliding door modules and terminal hinged door modules

Fasce di tamponamento

EN Fillers

Modelli

EN Models

Battente,

EN Hinged door

Disponibile per tutte le ante battenti,
EN Available for all hinged doors

Scorrevole,

EN Sliding door

Disponibile per tutte le ante scorrevoli,
EN Available for all sliding doors

Complanare,

EN Flush Sliding door

Disponibile per tutte le ante complanari,
EN Available for all flush sliding doors

Finiture

EN Finishes

Laccato Opaco o Lucido,
EN Matt or High Gloss
Lacquered

+RAL, Soft Touch

Essenza, EN Wood:
Borgogna, Canaletto,
Rovere Fumo, Rovere
Grigio, Rovere Laguna
Rovere Naturale, Rovere
Tabacco

Materico: Bianco, Cenere,
Seta, Alaska, Corsica



Tamponamenti ad anta

EN Fillers doors

Modelli

EN Models

Cornice, Manhattan,
Nastro, Tratto, Icona,
Plana

Tamponamento laterale
apribile ad anta battente
può essere accostato
anche a moduli con anta
scorrevole,
EN Hinged side filler can
be combined to sliding
door modules

Tamponamento superiore*,

EN Top filler*

01
Battente, EN Hinged doors
Cornice, Manhattan,
Nastro, Tratto, Icona,
Plana

*Solo per anta legno,
EN Only for wooden door

02
Scorrevole, EN Sliding door
Cornice, Manhattan,
Nastro, Tratto, Icona,
Plana

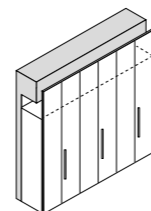

01

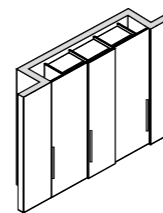

02



Cabine armadio
EN Walk-in closets

Sipario

Modularità EN Modularity

P 42.3 - 59 cm
L 47.8 - 57.8 - 67.8 - 97.8
- 117.8 - 137.8 - 147.8 cm
H 238.5 - 257.7 - 289.7 cm
su misura

D 16.65" - 23.23"
W 18.81" - 22.76" - 26.69"
38.50" - 46.38" - 54.25"
- 58.19"
H 93.90" - 101.46" - 114.06"
custom size

Accessori pag. 284
EN Accessories pag. 284

Finiture EN Finishes

Materico: Bianco,
Borgogna, Canaletto,
Rovere Laguna, Perlage
Conchiglia, PerlageTerra

Laccato Opaco,
EN Matt Lacquered

Riduzioni su misura EN Made-to measure solutions

Vedi pag. 291,
EN See pag. 291



I moduli cabina Sipario possono essere allestiti con tutti gli accessori interni previsti per i moduli armadio pag. 284. Possono essere abbinati a tutti i moduli di ante della collezione,

EN Sipario walk-in closet modules can be equipped with all internal accessories available for wardrobes on page 284. They can be combined with all the doors of the collection

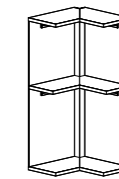
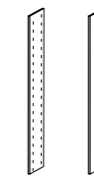
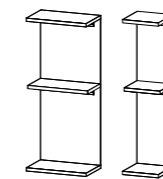
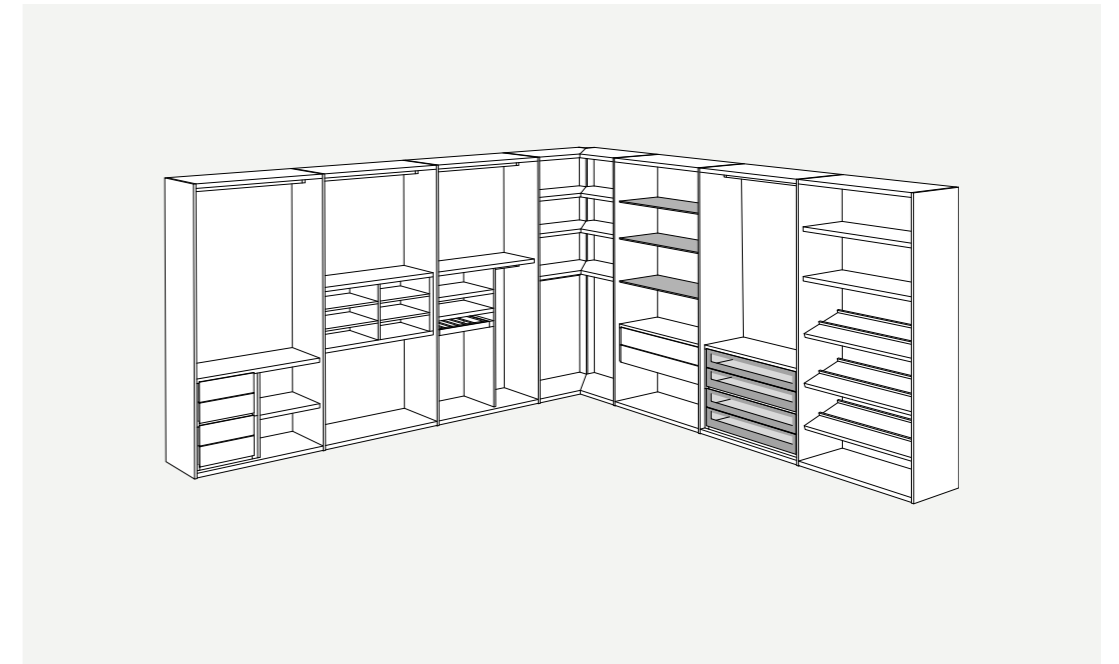

Moduli EN Modules

L 47.8 - 57.8 - 67.8 - 97.8
- 117.8 - 137.8 - 147.8 cm
H 238.5 - 257.7 - 289.7 cm
su misura

W 18.81" - 22.76" - 26.69"
- 38.50" - 46.38" - 54.25"
58.19"
H 93.90" - 101.46" - 114.06"
custom size

Divisori EN Partitions

L 22 cm
H 238.5 - 257.7 - 289.7 cm
su misura

W 8.70"
H 93.90" - 101.46" - 114.06"
custom size

Angolo EN Corner

L 94 x 94 cm - P 42.3 cm
110.7 x 110.7 - P 59 cm
H 238.5 - 257.7 - 289.7 cm
su misura

W 37.01" x 37.01" - P 16.65"
W 43.58" x 43.58" - P 23.23"
H 93.90" - 101.46" - 114.06"
custom size

Sipario con telaio

EN Sipario with frame

Modularità

EN Modularity

P 42.3 - 59 cm
 L 47.8 - 57.8 - 67.8 - 97.8
 - 117.8 - 137.8 - 147.8 cm
 H 238.5 - 257.7 - 289.7 cm
 su misura

D 16.65" - 23.23"
 W 18.81" - 22.76" - 26.69"
 38.50" - 43.58 - 46.38" -
 54.25"
 H 93.90" - 101.46" - 114.06"
 custom size

Accessori pag. 284
 EN Accessories pag. 284

Finiture

EN Finishes

Materico: Bianco,
 Borgogna, Canaletto,
 Rovere Laguna, Perlage
 Conchiglia, PerlageTerra

Laccato Opaco,
 EN Matt Lacquered

Riduzioni su misura

EN Made-to measure solutions

Vedi pag. 291,
 EN See pag. 291



I moduli cabina Sipario possono essere allestiti con tutti gli accessori interni previsti per i moduli armadio pag. 284

EN Sipario walk-in closet modules can be equipped with all internal accessories available for wardrobes on page 284

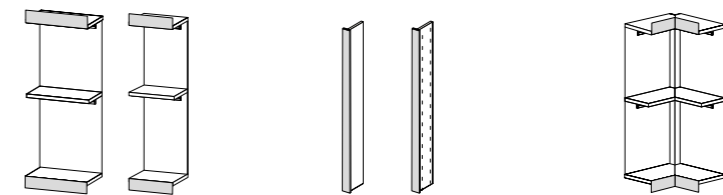
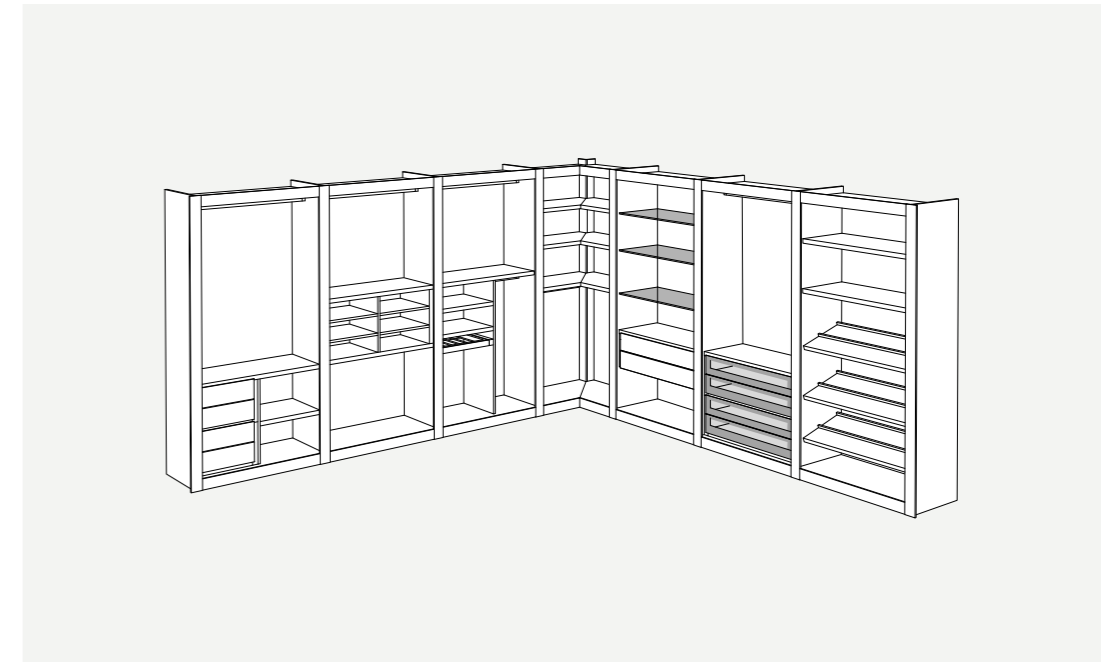

Moduli

EN Modules

L 47.8 - 57.8 - 67.8 - 97.8
 - 117.8 - 137.8 - 147.8 cm
 H 238.5 - 257.7 - 289.7 cm
 su misura

W 18.81" - 22.76" - 26.69"
 - 38.50" - 46.38" - 54.25"
 58.19"
 H 93.90" - 101.46" - 114.06"
 custom size

Divisori

EN Partitions

L 2.2 cm
 H 238.5 - 257.7 - 289.7 cm
 su misura

W 0.87"
 H 93.90" - 101.46" - 114.06"
 custom size

Angolo

EN Corner

L 94 x 94 cm - P 42.3 cm
 110.7 x 110.7 - P 59 cm
 H 238.5 - 257.7 - 289.7 cm
 su misura

W 37.01" x 37.01" - P 16.65"
 W 43.58" x 43.58" - P 23.23"
 H 93.90" - 101.46" - 114.06"
 custom size

Anteprima con schienali

EN Anteprima with back panels

Modularità

EN Modularity

L 50 - 70 - 90 - 110 cm
H 238.5 - 257.7 - 289.7 cm

W 19.69" - 27.56" - 35.43"
43.31"
H 93.90" - 101.46" - 114.06"

Accessori pag. 284
EN Accessories pag. 284

Finiture

EN Finishes

Materico: Bianco,
Borgogna, Canaletto,
Rovere Laguna, Perlage
Conchiglia, PerlageTerra

Laccato Opaco,
EN Matt Lacquered

Riduzioni su misura*

EN Made-to measure solutions*

Disponibili per cornici,
schienali legno o specchio,
ripiani, pedane e aste
appendiabiti,
EN Available for frames,
wooden or mirror back
panels, shelves, bases
and hanging rods

* Per limitazioni
consultare il listino,
EN For limitations please
see pricelist

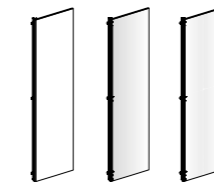
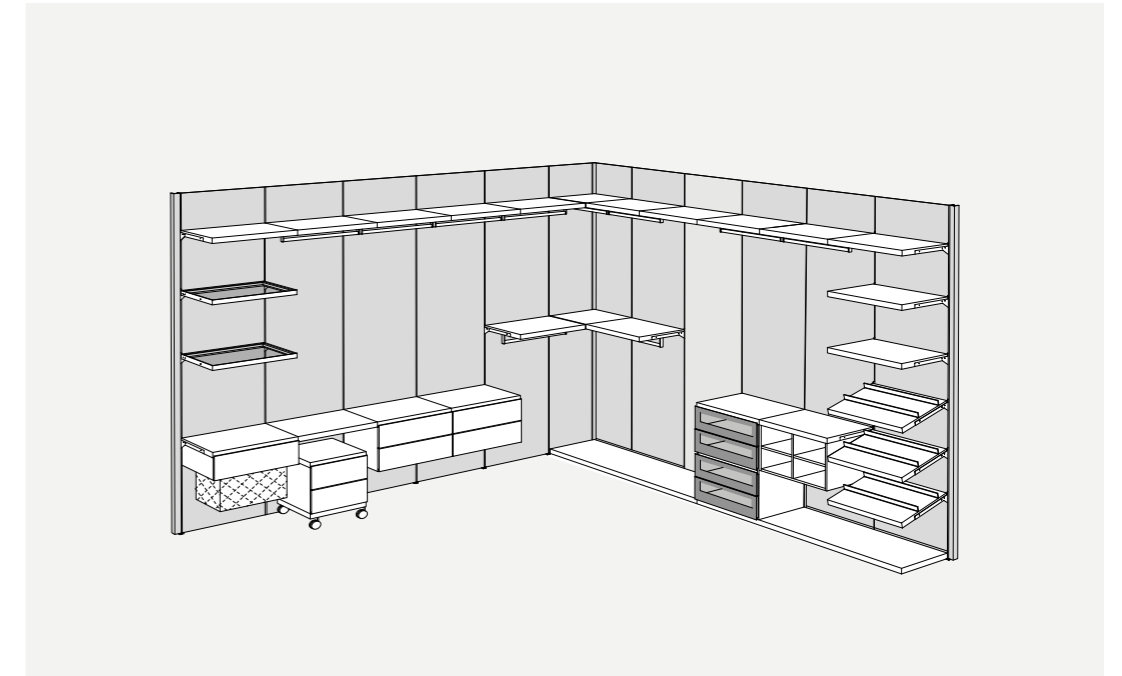

Schienali

EN Back panels

L 50 - 70 - 90 - 110 cm
H 238.5 - 257.7 - 289.7 cm

W 19.69" - 27.56" - 35.43"
43.31"
H 93.90" - 101.46" - 114.06"

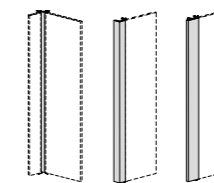

Cornici ad L, lineari, ad angolo, EN L shaped, straight, corner frames

L 6 cm da 5 a 21 cm -
10x10 cm
H 238.5 - 257.7 - 289.7 cm

W 2.36" from 1.97" to
8.27" - 3.94"x3.94"
H 93.90" - 101.46" - 114.06"

Anteprima senza schienali

EN Anteprima without back panels

Modularità

EN Modularity

L max 110 cm
H 238.5 - 257.7 - 289.7 cm

W max 43.31"
H 93.90" - 101.46" - 114.06"

Accessori pag. 284
EN Accessories pag. 284

Finiture montante

EN Vertical supports finishes

Alluminio pitturabile,
EN Paintable aluminum,
Manganese

Riduzioni su misura

EN Made-to measure solutions

Disponibili per montanti ripiani, pedane e aste appendiabiti,
EN Available for vertical supports, shelves, bases and hanging rods

* Per limitazioni consultare il listino,
EN For limitations please see pricelist

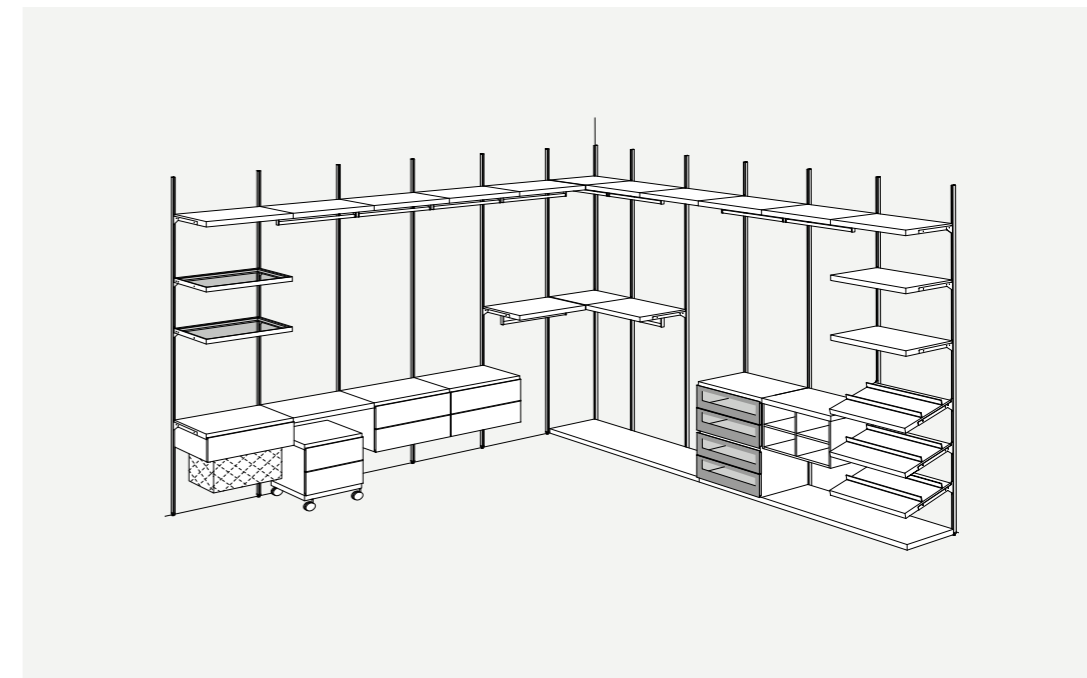

Montanti

EN Vertical supports

H 238.5 - 257.7 - 289.7 cm
H 93.90" - 101.46" - 114.06"

Schienali

EN Back panels

Modularità EN Modularity

Sp 1 cm
L 50 - 70 - 90 - 110 cm
H 238.5 - 257.7 - 289.7 cm

Th 0.39"
W 19.69" - 27.56" - 35.43"
43.31"
H 93.90" - 101.46" - 114.06"

Tipologie EN Types

01

Legno, EN Wood
Laccato Opaco,
EN Matt Lacquered

Materico: Bianco,
Borgogna, Canaletto,
Rovere Laguna, Perlage
Conchiglia, PerlageTerra

02

**Pelle Sintetica,
EN Synthetic leather**
Creta, Elephant, Talpa

03

Vetro, EN Glass
Bianco retroilluminato,
EN White back lit glass panel

04

**Vetro laccato Opaco o
Lucido, EN Matt or Glossy**
Lacquered glass
Bronzo Metallizzato



01



02



03

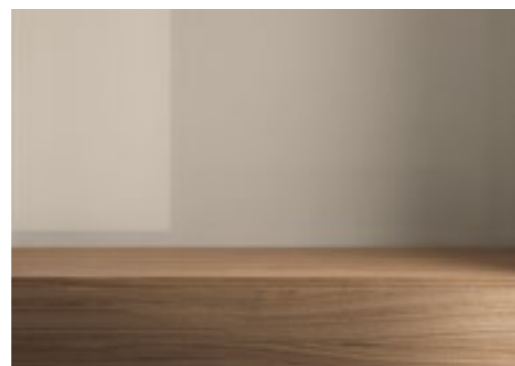

04

Tipologie EN Types

05

Specchio, EN Mirror
Argento, Fumé, Piombo

06

Materico:
Opaco o Lucido,
EN Matt or Glossy:
Gioia di carrara, Grafite,
Emperador

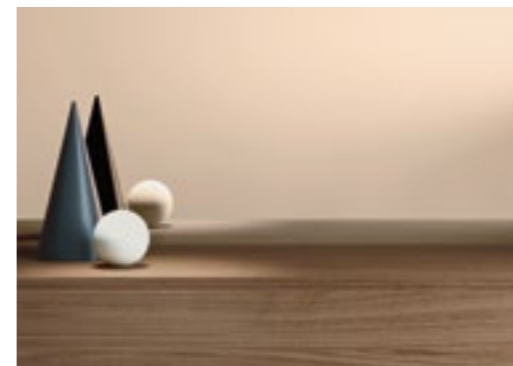

05



06

Ripiani e pedane con schienale

EN Shelves and bases with back panel

Tipologie EN Types

01
Ripiano con staffe a vista,
EN Shelf with visible
supports

Sp 4 cm P 39.5 - 51 cm
L min 14 - max 110 cm

Th 1.57" D 15.55" - 20.09"
W min 5.51" max 43.31"



01

02
Ripiano con staffe a
scomparsa,
EN Shelf with invisible
supports

Sp 4 cm P 39.5 - 51 cm
L min 14 max 300 cm

Th 1.57" D 15.55" - 20.09"
W min 5.51" max 118.11"



03

03
Ripiano portascarpe
con staffe a vista,
EN Shoe shelf with
visible supports

P 39.5 - 51 cm
L 50 - 70 - 90 - 110 cm

D 15.55" - 20.09"
W 19.69" - 27.56" - 35.43"
43.31"



04
Ripiano portascarpe
con staffe a scomparsa,
EN Shoe shelf with
invisible supports

P 39.5 - 51 cm
L 50 - 70 - 90 - 110 cm

D 15.55" - 20.09"
W 19.69" - 27.56" - 35.43"
43.31"

310



02

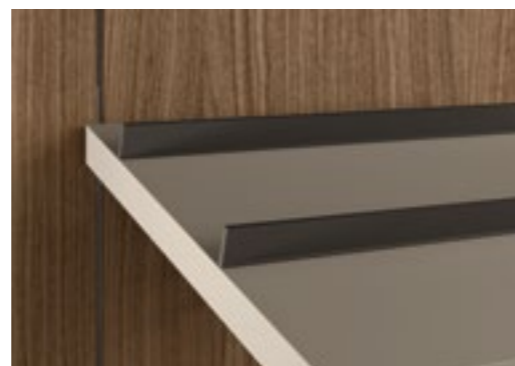

04

Tipologie EN Types

05
Ripiano in vetro Fumé
con telaio, EN Fumé glass
shelf with frame
Sp 3.5 cm Th 1.38"

P 39.5 - 51 cm
L 50 - 70 - 90 - 110 cm

D 15.55" - 20.09"
W 19.69" - 27.56" - 35.43"
43.31"



05

06
Pedane, EN Bases
Sp 4 cm Th 1.57"

P 39.5 - 51.1 cm
L min 14 max 300 cm

D 15.55" - 20.12"
W min 5.51" max 118.11"

Non disponibile in Pelle
Sintetica, EN Not available
in Synthetic Leather



06

Finiture EN Finishes

Laccato Opaco,
EN Matt Lacquered

Materico: Bianco,
Borgogna, Canaletto,
Rovere Laguna, Perlage
Conchiglia, PerlageTerra

Pelle Sintetica*,
EN Synthetic Leather*:
Creta, Elephant, Talpa

* Solo per ripiani con
staffe a vista, EN Only
for shelves with visible
supports

311

Ripiani e pedane senza schienale

EN Shelves and bases without back panel

Tipologie EN Types

01
Ripiano con staffe a vista,
EN Shelf with visible
supports

Sp 4 cm P 39.5 - 51 cm
L min 14 - max 110 cm

Th 1.57" D 15.55" - 20.09"
W min 5.51" max 43.31"



01

02
Ripiano con staffe a
scomparsa, EN Shelf with
invisible supports

Sp 4 cm P 39.5 - 51 cm
L min 14 max 300 cm

Th 1.57" D 15.55" - 20.09"
W min 5.51" max 118.11"



03

03
Ripiano portascarpe
con staffe a vista,
EN Shoe shelf with
visible supports

P 39.5 - 51 cm
L 50 - 70 - 90 - 110 cm

D 15.55" - 20.09"
W 19.69" - 27.56" - 35.43"
43.31"



04
Ripiano portascarpe
con staffe a scomparsa,
EN Shoe shelf with
invisible supports

P 39.5 - 51 cm
L 50 - 70 - 90 - 110 cm

D 15.55" - 20.09"
W 19.69" - 27.56" - 35.43"
43.31"

312



02



04

Tipologie EN Types

05
Ripiano in vetro fumè
con telaio, EN Fumé glass
shelf with frame
Sp 3.5 cm Th 1.38"

P 39.5 - 51 cm
L 50 - 70 - 90 - 110 cm

D 15.55" - 20.09"
W 19.69" - 27.56" - 35.43"
43.31"



05

06
Pedane, EN Bases
Sp 4 cm Th 1.57"

P 39.5 - 51.1 cm
L min 14 max 300 cm

D 15.55" - 20.12"
W min 5.51" max 118.11"

Non disponibile in Pelle
Sintetica, EN Not available
in Synthetic Leather



06

Finiture EN Finishes

Laccato Opaco,
EN Matt Lacquered

Materico: Bianco,
Borgogna, Canaletto,
Rovere Laguna, Perlage
Conchiglia, PerlageTerra

Pelle Sintetica*,
EN Synthetic Leather*:
Creta, Elephant, Talpa

* Solo per ripiani con
staffe a vista, EN Only
for shelves with visible
supports

313

Cassettiere

EN Drawer units

Tipologie EN Types

01
Cassettiera autoportante,
EN Floor sitting drawer unit

02
Cassettiera autoportante
con ruote, EN Free standing
drawer unit on castors

03
Cassettiera pensile,
EN Suspended drawer unit

04
Cassettiera sottopiano,
EN Under shelf drawer
unit



01



02



03



04

Frontali cassetti

EN Drawer fronts

Tipologie EN Types

01
Legno, EN Wood
H 18 - 36 cm
H 7.09" - 14.17"

02
Vetro, EN Glass
H 18 - 36 cm
H 7.09" - 14.17"

03
Con oblò, EN See-through
glass front
H 18 cm - H 7.09"

04
Pelle sintetica,
EN Synthetic leather

Finiture EN Finishes

Materico: Bianco,
Borgogna, Canaletto,
Rovere Laguna, Perlage
Conchiglia, PerlageTerra

Laccato Opaco,
EN Matt Lacquered

Vetro, EN Glass:
Laccato Opaco o Lucido,
EN Matt or Glossy
Lacquered

Con oblò, EN See-through
glass front:
Extrachiaro Trasparente
con cornice Bianco, Fumé
con cornice Nero,
EN Extrachiaro Trasparente
with White frame, Fumé
with Black frame

Pelle Sintetica
EN Synthetic Leather:
Creta, Elephant, Talpa



01



02



03



04

Cassettiere autoportanti

EN Floor sitting drawer units

Modularità EN Modularity

L 50 - 70 - 90 - 110 cm
P 41.5* - 53.3 cm
H 44 - 82 cm

W 19.69" - 27.56" - 35.43"
43.31"
D 16.34"* - 20.98"
H 17.32" - 32.28"

H 44 cm - 17.32"
1 Cestone, EN Tall drawer

2 Cassetti, EN Drawers

2 Cassetti con oblò,
EN Drawers with
see-through glass front

H 82 cm - 32.28"
2 Cestoni, EN Tall drawers

2 Cassetti + 1 Cestone,
EN 2 Drawers + 1 Tall drawer

4 Cassetti, EN Drawers

4 Cassetti con oblò,
EN Drawers with
see-through glass front

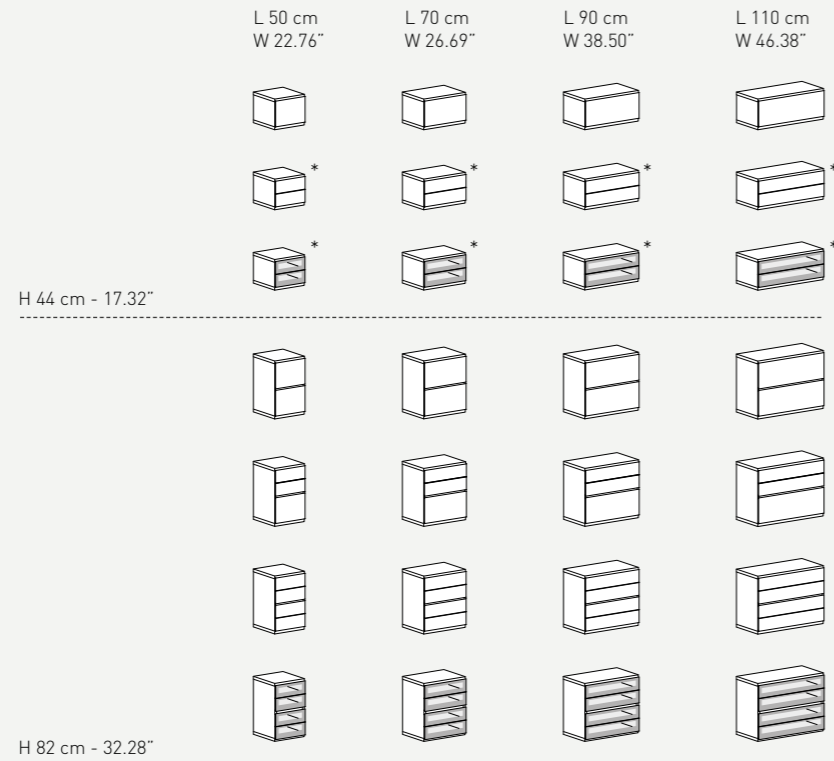

Cassettiere sottopiano

EN Under shelf drawer units

Modularità EN Modularity

L 50 - 70 - 90 - 110 cm
P 41.5* - 53.3 cm

W 19.69" - 27.56" - 35.43"
43.31" D 16.34"* - 20.98"

H 35.2 cm - 13.86"
1 Cestone, EN Tall drawer

2 Cassetti, EN Drawers

2 Cassetti con oblò,
EN Drawers with
see-through glass front

H 52.8 cm - 20.79"
2 Cestoni, EN Tall drawers

2 Cassetti + 1 Cestone,
EN 2 Drawers + 1 Tall drawer

4 Cassetti, EN Drawers

4 Cassetti con oblò,
EN Drawers with
see-through front

H 70.4 cm - 27.72"
3 Cestoni, EN Tall drawer 6
Cassetti, EN Drawers

2 Cassetti + 2 Cestoni,
EN 2 Drawers + 2 Tall drawers

4 Cassetti + 1 Cestone,
EN 4 Drawers + 1 Tall drawer

6 Cassetti, EN Drawers

6 Cassetti con oblò,
EN Drawers with
see-through glass front

Le cassettiere sottopiano
devono essere completate
con un ripiano superiore
di chiusura e con una
pedana inferiore, EN Under
shelf drawer units must
always have a finishing
top shelf as well as a floor
sitting base

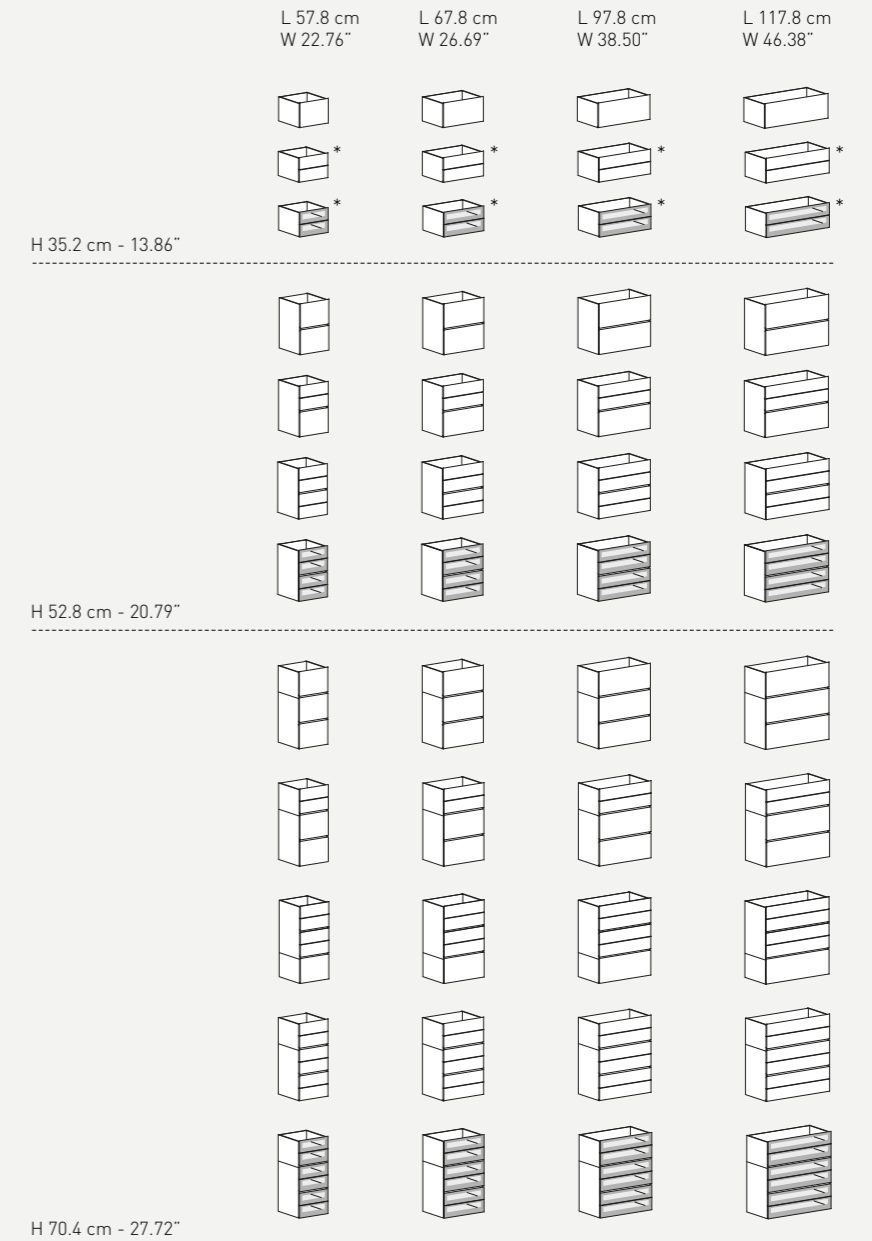

Cassettiere pensili

EN Suspended drawer units

Modularità EN Modularity

L 50 - 70 - 90 - 110 cm
P 41.5* - 53 cm

W 19.69" - 27.56" - 35.43"
43.31"
D 16.34"* - 20.87"

H 17 cm - 6.69"

1 Cassetto, EN Drawer

1 Cassetto con oblò,
EN Drawer with
see-through glass front

H 38 cm - 14.96"

1 Cestone, EN Tall drawer

2 Cassetti, EN Drawers

1 Cassetti con oblò,
EN Drawers with
see-through glass front

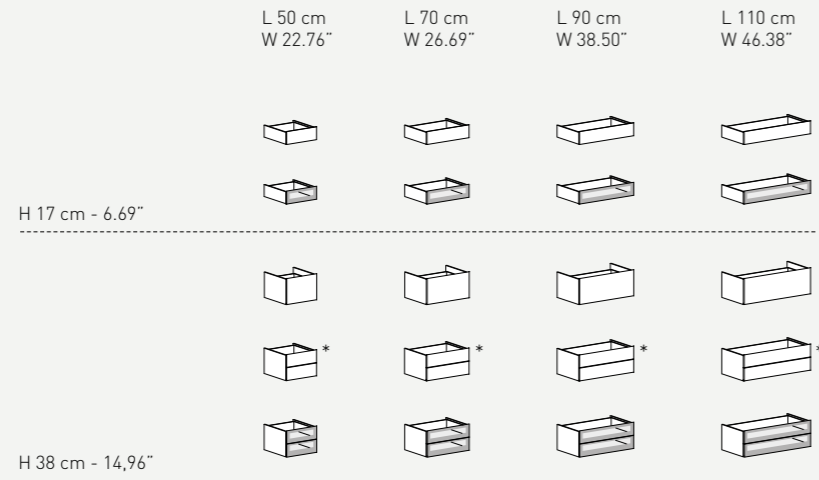

Le cassettiere pensili
devono essere
completate con un
ripiano superiore di
chiusura,
EN Suspended drawer
units must always have a
finishing top shelf

Raster pensili

EN Suspended cubbies

Modularità EN Modularity

L 50 - 70 - 90 - 110 cm
P 41.5 - 51.1 cm
H 36 - 53 - 71 cm

W 19.69" - 27.56" - 35.43"
43.31"
D 16.34" - 20.12"
H 14.17" - 20.87" - 27.95"

Contenitori per raster, EN Boxes for cubbies

L 31.2 - 41.2 - 45 - 51.2 cm
P 50.5 cm
H 14 cm

W 12.28" - 16.22" - 17.72"
- 20.16"
D 19.88"
H 5.51"

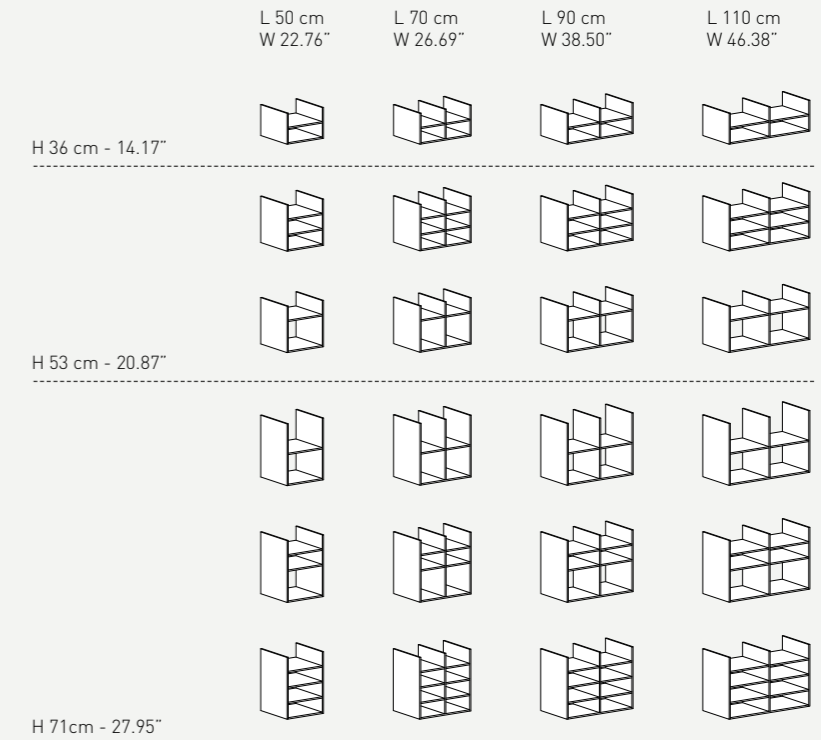

Telai estraibili e accessori

EN Pull-out frames and accessories

Tipologie EN Types

01
Vassoio metallo,
EN Metal tray

H 6 cm - 2.36"
Finitura, EN Finish
Manganese

02
Piano vetro Fumé,
EN Fumé glass shelf

H 6 cm - 2.36"

03
Piano in legno,
EN Wooden shelf

H 6 cm - 2.36"
Finiture, EN Finishes
Materico: Bianco,
Borgogna, Canaletto,
Rovere Laguna, Perlage
Conchiglia, PerlageTerra

Laccato Opaco,
EN Matt lacquered

04
Griglia per vassoio,
EN Grid for tray

H 6 cm - 2.36"
Finitura, EN Finish
Manganese

05
Portapantaloni + vaschetta,
non disponibile L 70 cm
EN Trousers rack + tray,
not available W 27.56"

H 6 cm - 2.36"
Finitura, EN Finish
Manganese



01



02



03



04



05



06

Tipologie EN Types

06
Portapantaloni +
portagonna non
disponibile L 70 cm,
EN Trousers + skirt rack
not available W 27.56"

H 6 cm - 2.36"
Finitura, EN Finish
Manganese

07
Portapantaloni,
EN Trousers rack

H 6 cm - 2.36"
Finitura, EN Finish
Manganese

08
Portagonna, EN Skirt rack

H 6 cm - 2.36"
Finitura, EN Finish
Manganese

09
Scarpiera in metallo,
EN Metal shoe rack

H 15 cm - 5.91"

Finitura, EN Finish
Manganese

10
Sacche portabiancheria
in tessuto trapuntato,
EN Hampers in tufted
fabric

H 31 cm - 12.20"



06



07



08



09

Complementi cabine
EN Walk-in closet complements

Island

Modularità, EN Modularity

L 144 - 184 - 224 cm
H 85 cm
P 58 - 107 cm

W 56.69" - 72.44" - 88.19"
H 33.46"
D 22.83" - 42.13"

Finiture, EN Finishes

Materico: Bianco,
Borgogna, Canaletto,
Rovere Laguna, Perlage
Conchiglia, PerlageTerra

Laccato Opaco,
EN Matt Lacquered

Frontali cassetti, EN Drawer frontals

Materico: Bianco,
Borgogna, Canaletto,
Rovere Laguna, Perlage
Conchiglia, PerlageTerra

Laccato Opaco,
EN Matt Lacquered

Pelle Sintetica
EN Synthetic Leather:
Creta, Elephant, Talpa



Attrezzabilità EN Accessories

Il modulo può essere
completato con la teca
superiore in vetro, con
vassoi rivestiti nelle
diverse conformazioni,
con telai estraibili
completi di accessori
(vassoio in metallo, piano
in legno materico o vetro
fumè trasparente) e
serratura elettronica,

EN The module can be
supplied with a glass top
display case, with lined
trays available in various
configurations, with
pull-out trays completed
with accessories for the
drawer's interior (metal
tray, wood or transparent
Fumé glass shelf) and the
electronic lock

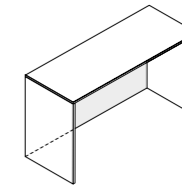

Struttura con schienale EN Structure with back

L 144 - 184 - 224 cm
H 85 cm
P 58 cm

W 56.69" - 72.44" - 88.19"
H 33.46"
D 22.83"

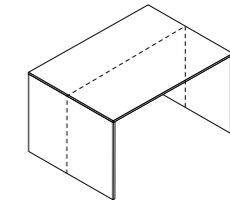

Struttura doppia EN Double structure

L 144 - 184 - 224 cm
H 85 cm
P 107 cm

W 56.69" - 72.44" - 88.19"
H 33.46"
D 42.13"

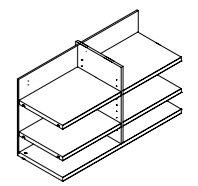

Vano con ripiani EN Shelves

L 140 - 180 - 220 cm
H 83 cm
P 53 cm

W 55.12" - 72.44" - 88.19"
H 33.46"
D 20.87"

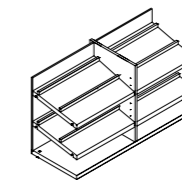

Vano con portascarpe EN Shoe shelves

L 140 - 180 - 220 cm
H 83 cm
P 53 cm

W 55.12" - 72.44" - 88.19"
H 33.46"
D 20.87"

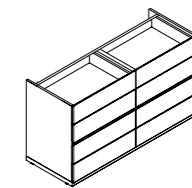

Vano con cassetti EN Drawers

L 140 - 180 - 220 cm
H 83 cm
P 53 cm

W 55.12" - 72.44" - 88.19"
H 33.46"
D 20.87"

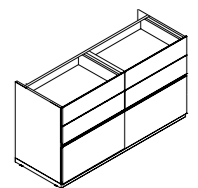

Vano con cassetto e cestone, EN Drawers + tall drawer

L 140 - 180 - 220 cm
H 83 cm
P 53 cm

W 55.12" - 72.44" - 88.19"
H 33.46"
D 20.87"

Island accessori

EN Island accessories

Finiture EN Finishes

Teca, EN Display case

Vetro trasparente,
EN Transparent glass

Vassoi, EN Trays

Pelle Sintetica,
EN Synthetic Leather
Creta, Elephant

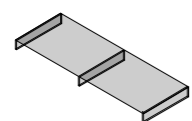

Teca singola
EN Half glass display case

L 144 - 184 - 224 cm
H 10 cm
P 58 cm

W 56.69" - 72.44" - 88.19"
H 3.94"
D 22.83"

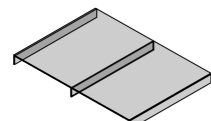

Teca doppia
EN Glass display case

L 144 - 184 - 224 cm
H 10 cm
P 107 cm

W 56.69" - 72.44" - 88.19"
H 3.94"
D 42.13"

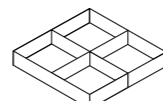

Vassoio tipo A singolo
EN Half tray type A

L 70 - 90 - 110 cm
H 6 cm
P 57 cm

W 27.56" - 35.95" - 43.31"
H 2.36"
D 22.44"

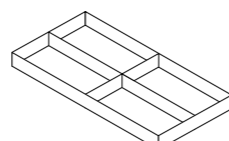

Vassoio tipo A doppio
EN Double tray type A

L 70 - 90 - 110 cm
H 6 cm
P 106 cm

W 27.56" - 35.95" - 43.31"
H 2.36"
D 41.73"

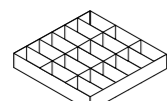

Vassoio tipo B singolo
EN Half tray type B

L 70 - 90 - 110 cm
H 6 cm
P 57 cm

W 27.56" - 35.95" - 43.31"
H 2.36"
D 22.44"

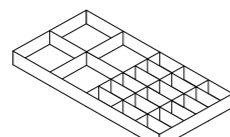

Vassoio tipo B doppio
EN Double tray type B

L 70 - 90 - 110 cm
H 6 cm
P 57 cm

W 27.56" - 35.95" - 43.31"
H 2.36"
D 22.44"

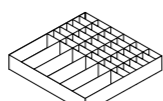

Vassoio tipo C singolo
EN Half tray type C

L 70 - 90 - 110 cm
H 6 cm
P 57 cm

W 27.56" - 35.95" - 43.31"
H 2.36"
D 22.44"

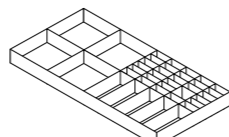

Vassoio tipo C doppio
EN Double tray type C

L 70 - 90 - 110 cm
H 6 cm
P 57 cm

W 27.56" - 35.95" - 43.31"
H 2.36"
D 22.44"

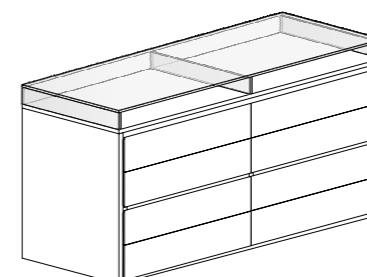

Modulo singolo con cassetti e teca superiore,
EN Single unit with drawers and glass display case

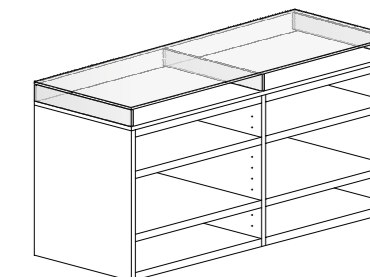

Modulo singolo con ripiani e teca superiore,
EN Single unit with shelves and glass display case

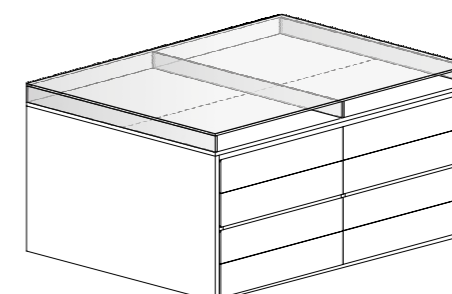

Modulo doppio con cassetti e teca superiore,
EN Double unit with drawers and glass display case

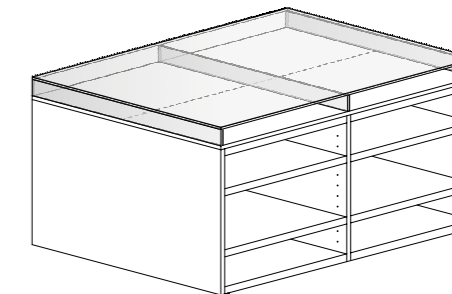

Modulo doppio con ripiani e teca superiore,
EN Double unit with shelves and glass display case

Snake

Finiture EN Finishes

Acciaio spazzolato,
EN Brushed steel



Le dimensioni a passo 14 cm danno la possibilità di creare qualsiasi disegno a parete,
EN Thanks to 5.51" pitch virtually any wall configuration is possible

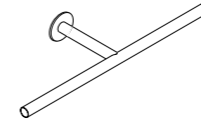

Tubi lineari EN Straight pipes

L 60 - 74 - 88 - 102 - 116
130 - 144 - 158 - 172 - 200 cm
P 27 cm Ø 3.5 cm
Portata 20 kg distribuito
al ml

W 23.62" - 29.13" - 34.65"
- 40.16 - 45.67" - 51.18"
- 56.69" - 62.20" - 67.72"
- 78.74"
D 10.63" Ø 1.38"
Max 20 kg per linear
meter evenly distribute



Connessione lineare EN Straight junction

L 10 cm Ø 3.5 cm
W 3.94" Ø 1.38"

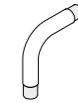

Connessione a L EN L junction

L 14 H 14 Ø 3.5 cm
W 5.51" H 5.51" Ø 1.38"

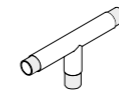

Connessione a T EN T junction

L 24 H 14 Ø 3.5 cm
W 9.45" H 5.51" Ø 1.38"

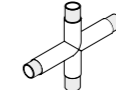

Connessione a croce EN Cross junction

L 24 H 24 cm Ø 3.5 cm
W 9.45" H 9.45" Ø 1.38"



Terminale a parete EN Wall terminal

L 14 cm P 27 cm Ø 3.5 cm
W 5.51" D 10.63" Ø 1.38"

Vista sistema di chiusura

EN Vista door system

Il sistema di chiusura Vista si caratterizza per la totale assenza di telai e per la modularità al millimetro. Binari e ante vengono sempre realizzati su misura,

EN A characteristic of the Vista door system is the absence of frames and the extremely wide modularity. Rails and doors are always made to measure

Binario monorotaia

EN Single track

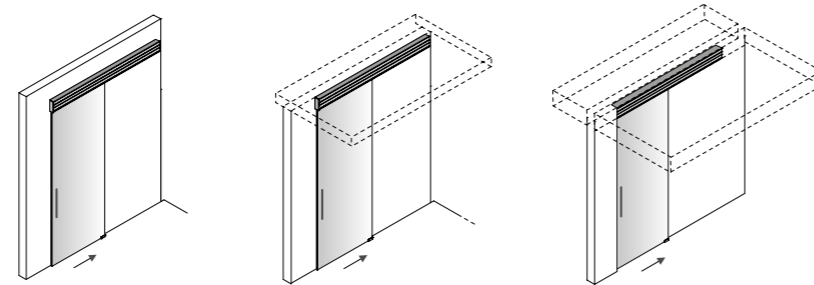

A parete,

EN Wall mounted

L min 135 max 600 cm
W min 53.15" max 236.22"

A soffitto,

EN Ceiling mounted

L min 135 max 600 cm
W min 53.15" max 236.22"

Ad incasso,

EN Recessed

L min 135 max 600 cm
W min 53.15" max 236.22"

Binario monorotaia + pannello fisso

EN Single track + fixed panel

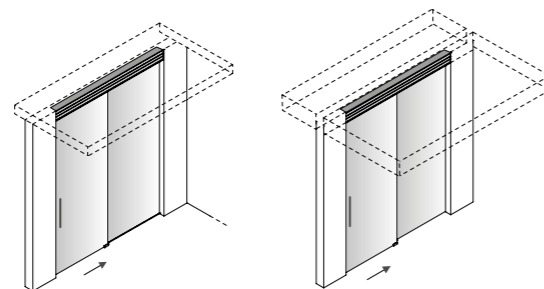

A soffitto,

EN Ceiling mounted

L min 138 max 600 cm
W min 54.33" max 236.22"

Ad incasso,

EN Recessed

L min 138 max 600 cm
W min 54.33" max 236.22"

Binario birotaia

EN Double track

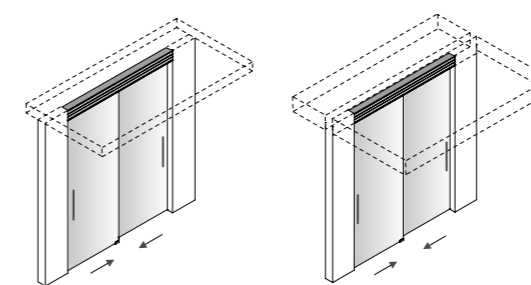

A soffitto,

EN Ceiling mounted

L min 138 max 600 cm
W min 54.33" max 236.22"

Ad incasso,

EN Recessed

L min 138 max 600 cm
W min 54.33" max 236.22"

Pannelli fissi divisori

EN Fixed panels dividers

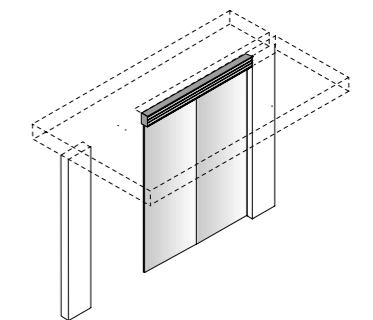

Pannello fisso divisorio,

EN Fixed panel divider

L min 70 max 600 cm
W min 27.56" max 236.22"

Angolari

EN Corner

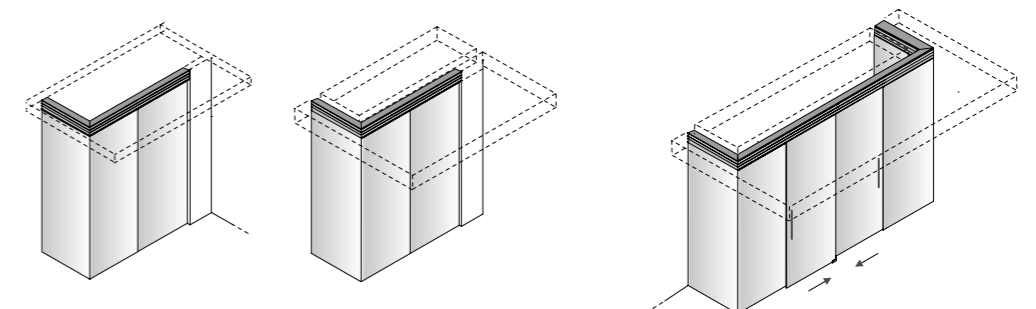

Pannello fisso soffitto,

EN Ceiling mounted fixed panel

L min 70 max 600 cm
W min 27.56" max 236.22"

Pannello fisso ad incasso,

EN Recessed fixed panel

L min 70 max 600 cm
W min 27.56" max 236.22"

2 pannelli fissi e 2 ante su binario birotaia a soffitto,

EN 2 fixed panels and 2 doors on recessed double track

L min 70 max 600 cm
W min 27.56" max 236.22"

Vista con anta Crystal

EN Vista with Crystal door

Finiture EN Finishes

Finiture anta, EN Door finishes

Vetro, ^{EN} Glass:
Laccato Opaco o Lucido,
^{EN} Matt or Glossy
Lacquered

Fumé Trasparente,
Trama Argento, Trama
Bronzo, Trama Fumé

Finiture Binario, EN Track Finishes

Alluminio Anodizzato o
pitturabile con tempere
murarie, ^{EN} Anodised or
paintable aluminum

Maniglie EN Handles

Con Gola, ^{EN} With groove
U40

Finiture Metallo,
^{EN} Metal Finishes:
Bronzo, Cromo, Oro,
Rame, Titanio

Laccato Opaco,
^{EN} Matt Lacquered



Modularità EN Modularity

L da 70 a 120 cm
H da 190 a 280 cm

W from 27.56" to 47.24"
H from 74.80" to 110.24"

Pannello fisso, EN Fixed panel

L da 70 a 120 cm
H da 190 a 280 cm

W from 27.56" to 47.24"
H from 74.80" to 110.24"

Binario di scorrimento, EN Track

L max 600 cm
W max 236.22"

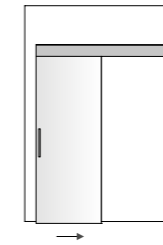

Anta scorrevole con binario a parete, EN Sliding door with wall mounted track

Dimensione vano,
^{EN} Opening:

L da 68 a 118 cm
H da 186 a 276 cm

W from 26.77" to 46.46"
H from 73.22" to 108.66"

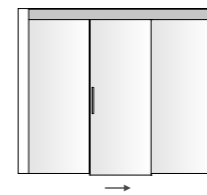

Anta scorrevole e 2 pannelli fissi binario a soffitto, ^{EN} Door and 2 fixed panels on a ceiling mounted track

Dimensione vano,
^{EN} Opening:

L da 206 a 356 cm
H da 199 a 289 cm

W from 81.10" to 140.16"
H from 78.35" to 113.78"

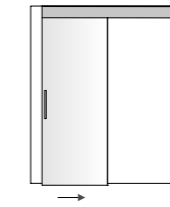

Anta scorrevole con binario a soffitto, EN Sliding door with ceiling mounted track

Dimensione vano,
^{EN} Opening:

L da 68 a 118 cm
H da 199 a 289 cm

W from 26.77" to 46.46"
H from 78.35" to 113.78"

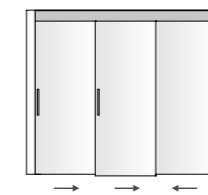

3 ante scorrevoli con binario a soffitto, EN 3 sliding doors with ceiling mounted track

Dimensione vano,
^{EN} Opening:

L da 206 a 356 cm
H da 199 a 289 cm

W from 81.10" to 140.16"
H from 78.35" to 113.78"

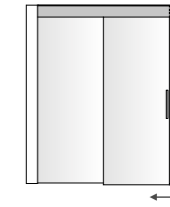

Anta scorrevole e pannello fisso con binario a soffitto, EN Door and fixed panel on ceiling mounted track

Dimensione vano,
^{EN} Opening:

L da 138 a 238 cm
H da 199 a 289 cm

W from 54.33" to 93.70"
H from 78.35" to 113.78"

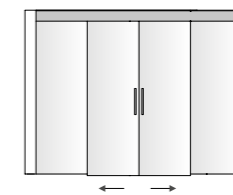

2 ante scorrevoli e 2 pannelli fissi binario a soffitto, ^{EN} 2 sliding doors and 2 fixed panels on a ceiling mounted track

Dimensione vano,
^{EN} Opening:

L da 276 a 476 cm
H da 199 a 289 cm

W from 108.66" to 187.40"
H from 78.35" to 113.78"

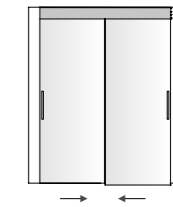

2 ante scorrevoli con binario a soffitto, EN 2 sliding doors with ceiling mounted track

Dimensione vano,
^{EN} Opening:

L da 138 a 238 cm
H da 199 a 289 cm

W from 54.33" to 93.70"
H from 78.35" to 113.78"

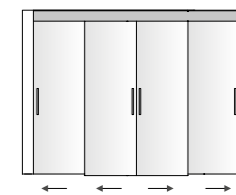

4 ante scorrevoli binario a soffitto, EN 4 sliding doors on a ceiling mounted track

Dimensione vano,
^{EN} Opening:

L da 276 a 476 cm
H da 199 a 289 cm

W from 108.66" to 187.40"
H from 78.35" to 113.78"

Vista con anta Plana

EN Vista with Plana door

Finiture EN Finishes

Finiture anta, EN Door finishes

Laccato Opaco o Lucido,
Alaska Laccato, EN Matt
or High Gloss Lacquered,
Alaska Lacquered

Soft touch

Essenza, EN Wood:
Borgogna, Canaletto,
Rovere Fumo, Rovere
Grigio, Rovere Laguna
Rovere Naturale, Rovere
Tabacco

Materico: Bianco, Cenere,
Seta, Alaska, Corsica

Pitturabile con tempere
murarie, EN Paintable

Finiture Binario, EN Track Finishes

Alluminio Anodizzato o
pitturabile con tempere
murarie, EN Anodised
aluminum, paintable
aluminum

Maniglie EN Handles

U40

Finiture Metallo,
EN Metal Finishes:
Bronzo, Cromo, Oro,
Rame, Titanio

Laccato Opaco,
EN Matt Lacquered

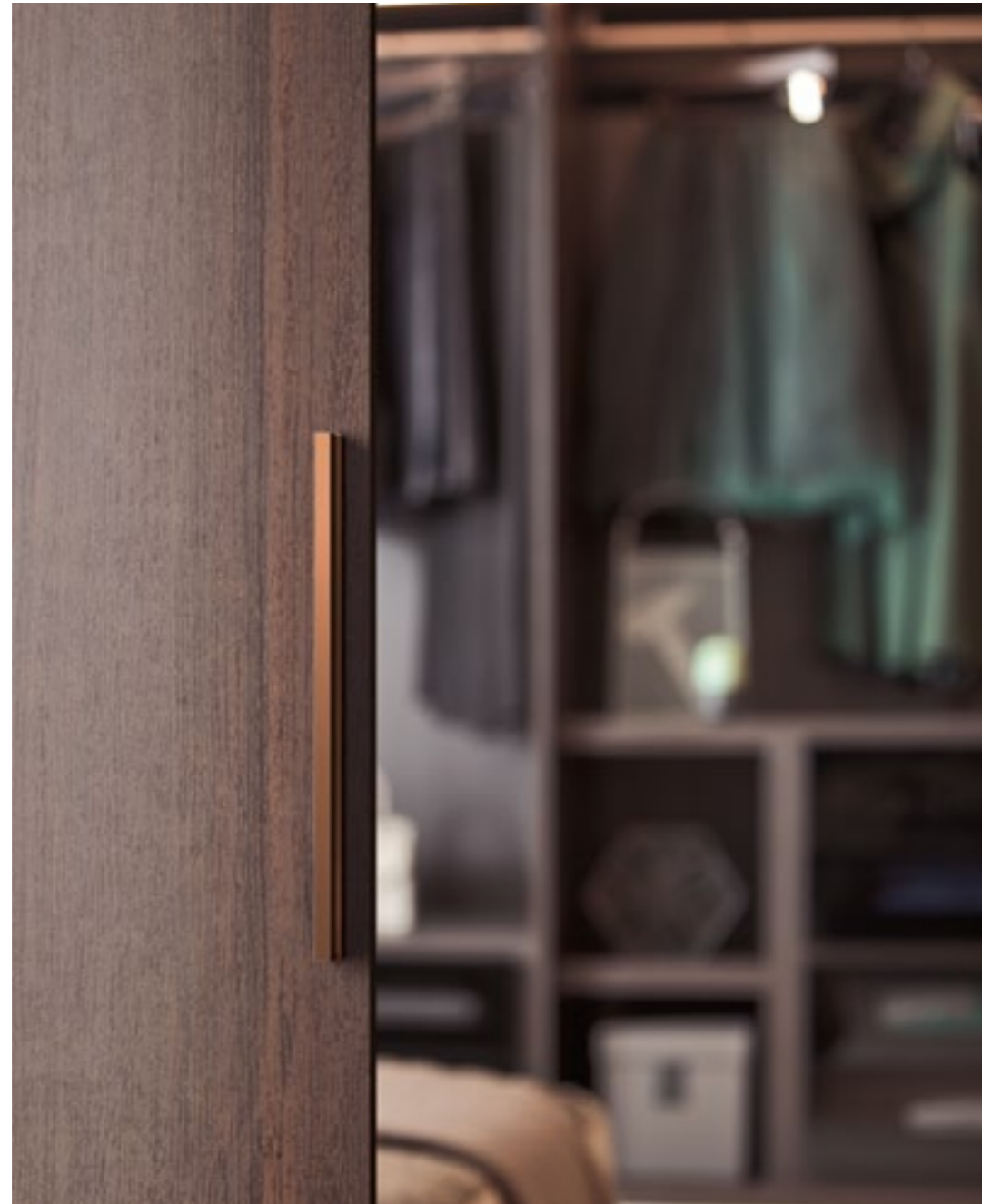

Modularità EN Modularity

L da 70 a 120 cm
H da 190 a 280 cm

W from 27.56" to 47.24"
H from 74.80" to 110.24"

Pannello fisso, EN Fixed panel

L da 70 a 120 cm
H da 190 a 280 cm

W from 27.56" to 47.24"
H from 74.80" to 110.24"

Binario di scorrimento, EN Track

L max 600 cm
W max 236.22"

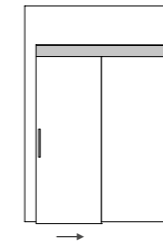

Anta scorrevole con binario a parete, EN Sliding door with wall mounted track

Dimensione vano,
EN Opening:

L da 68 a 118 cm
H da 186 a 276 cm

W from 26.77" to 46.46"
H from 73.22" to 108.66"

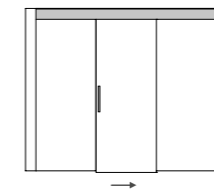

3 ante scorrevoli con binario a soffitto, EN 3 sliding doors with ceiling mounted track

Dimensione vano,
EN Opening:

L da 206 a 356 cm
H da 199 a 289 cm

W from 81.10" to 140.16"
H from 78.35" to 113.78"

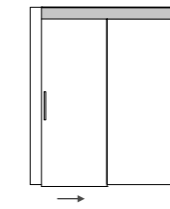

Anta scorrevole con binario a soffitto, EN Sliding door with ceiling mounted track

Dimensione vano,
EN Opening:

L da 68 a 118 cm
H da 199 a 289 cm

W from 26.77" to 46.46"
H from 78.35" to 113.78"

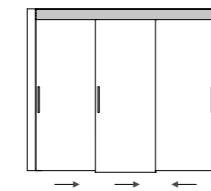

Anta scorrevole e 2 pannelli fissi binario a soffitto, EN Sliding doors and 2 fixed panels on a ceiling mounted track

Dimensione vano,
EN Opening:

L da 206 a 356 cm
H da 199 a 289 cm

W from 81.10" to 140.16"
H from 78.35" to 113.78"

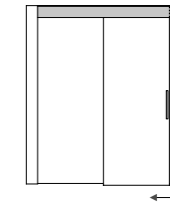

Anta scorrevole e pannello fisso con binario a soffitto, EN Sliding door and fixed panel on ceiling mounted track

Dimensione vano,
EN Opening:

L da 138 a 238 cm
H da 199 a 289 cm

W from 54.33" to 93.70"
H from 78.35" to 113.78"

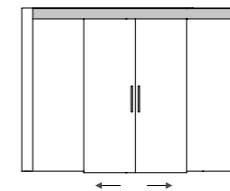

2 ante scorrevoli e 2 pannelli fissi binario a soffitto, EN 2 sliding doors and 2 fixed panels on a ceiling mounted track

Dimensione vano,
EN Opening:

L da 276 a 476 cm
H da 199 a 289 cm

W from 108.66" to 187.40"
H from 78.35" to 113.78"

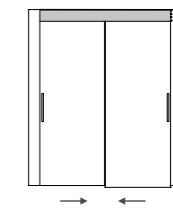

2 ante scorrevoli con binario a soffitto, EN 2 sliding doors with ceiling mounted track

Dimensione vano,
EN Opening:

L da 138 a 238 cm
H da 199 a 289 cm

W from 54.33" to 93.70"
H from 78.35" to 113.78"

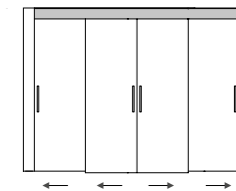

4 ante scorrevoli binario a soffitto, EN 4 sliding doors on a ceiling mounted track

Dimensione vano,
EN Opening:

L da 276 a 476 cm
H da 199 a 289 cm

W from 108.66" to 187.40"
H from 78.35" to 113.78"

PIANCA

Via dei Cappellari, 20
31018 – Gaiarine, Treviso
ITALY

T +39 0434 756911
F +39 0434 75330

info@pianca.com
pianca.com

p.iva IT 01682580269

Set design

Calvi Brambilla

Styling

Elena Caponi Studio

Artwork

Emilio Nanni

Graphic Design

makethatstudio

Photography & Renderings

NudesignStudio

Copywriting

Silvia Perrini

Printed

Sincromia COD.181111

Settembre, 2018

Vietata la riproduzione a qualsiasi scopo.

Campione promozionale gratuito non destinato alla vendita.
Escluso iva art.2 comma 3 D.P.R. 633/72 - esonerato da documento di trasporto art.4 punto 6 D.P.R. 627/78

Pianca si riserva di apportare, senza preavviso, le modifiche necessarie al fine di migliorare il funzionamento e la qualità dei propri prodotti. Si prega di consultare i listini e relativi aggiornamenti per aspetti tecnici e dimensionali. Colori e materiali hanno valore puramente rappresentativo.

^{EN} Pianca reserves the right to apply the necessary modifications without notice, in order to improve the performance and quality of its products. Please see the pricelists and relevant updates for technical data and dimensions. Colours and materials serve merely as an example.

Thanks to

Agustina Bottoni, Andrea Cardone, Artemide, Astep, Astrid Luglio per Tonatto Profumi, AYTM, Bibi Smit, Birgit Severin, Cristina Celestino, Daandesign, Dechem, Diego Zanella, Duecitti, Edizioni Design, Feelomena, Ferruccio De Vecchi, Ginevra Taccola, Giunone Couture, Ibrigu, Il Fanale, IL Independent Label, Jcp Design, Jeremie Duprey, Kristina Dam, Kundalini, Maatroom, Maniceramics, Matthias Kaiser, MMLampadari, Nahoor, Natascha Madeiski, Petite Friture, Philippe Tabet, Portego, Pulpo, Rodo since 1956, Sandra Davolio, Serena Confalonieri, Vanessa Mitrani, Verreum

Works of art

**Lorenzo Mazza,
Ivan De Menis, courtesy of Project B Gallery**

PIANCA azienda certificata FSC®



**Il marchio della
gestione forestale
responsabile**

Cerca i prodotti certificati FSC®

